

YELİZ YOLDAŞ

A Ph.D. Thesis

AGU 2021

DEVELOPMENT OF CONTROL STRATEGIES IN SMART MICROGRIDS

A THESIS
SUBMITTED TO THE DEPARTMENT OF ELECTRICAL AND
COMPUTER ENGINEERING
AND THE GRADUATE SCHOOL OF ENGINEERING AND SCIENCE
OF ABDULLAH GUL UNIVERSITY
IN PARTIAL FULFILLMENT OF THE REQUIREMENTS
FOR THE DEGREE OF
DOCTOR OF PHILOSOPHY

By
Yeliz YOLDAŞ
September 2021

DEVELOPMENT OF CONTROL STRATEGIES IN SMART MICROGRIDS

A THESIS

SUBMITTED TO THE DEPARTMENT OF ELECTRICAL AND COMPUTER
ENGINEERING AND THE GRADUATE SCHOOL OF ENGINEERING AND
SCIENCE OF ABDULLAH GUL UNIVERSITY

IN PARTIAL FULFILLMENT OF THE REQUIREMENTS

FOR THE DEGREE OF
DOCTOR OF PHILOSOPHY

By

Yeliz YOLDAŞ

September 2021

SCIENTIFIC ETHICS COMPLIANCE

I hereby declare that all information in this document has been obtained in accordance with academic rules and ethical conduct. I also declare that, as required by these rules and conduct, I have fully cited and referenced all materials and results that are not original to this work.

Name-Surname: Yeliz YOLDAŞ

Signature :

REGULATORY COMPLIANCE

Ph.D. thesis titled “Development of Control Strategies in Smart Microgrids” has been prepared in accordance with the Thesis Writing Guidelines of the Abdullah Gül University, Graduate School of Engineering & Science.

Prepared By
Yeliz YOLDAŞ

Advisor
Assoc. Prof. Ahmet ÖNEN

Head of the Electrical and Computer Engineering Program
Assoc. Prof. Kutay İÇÖZ

ACCEPTANCE AND APPROVAL

Ph.D. thesis titled “Development of Control Strategies in Smart Microgrids” and prepared by Yeliz YOLDAŞ has been accepted by the jury in the Electrical and Computer Engineering Graduate Program at Abdullah Gül University, Graduate School of Engineering & Science.

/ / 2021

JURY:

Advisor : Assoc. Prof. Ahmet ÖNEN

Member : Assist. Prof. Selçuk GÖREN

Member : Prof. İrfan ALAN

Member : Prof. Ferhat DALDABAN

Member : Assist. Prof. Nurettin ÜSTKOYUNCU

APPROVAL:

The acceptance of this Ph.D. thesis has been approved by the decision of the Abdullah Gül University, Graduate School of Engineering & Science, Executive Board dated / / 2021 and numbered

/ /

Graduate School Dean
Prof. Dr. Hakan USTA

ABSTRACT

DEVELOPMENT OF CONTROL STRATEGIES IN SMART MICROGRIDS

Yeliz YOLDAŞ
Ph.D. in Electrical and Computer Engineering
Advisor: Assoc. Prof. Ahmet ÖNEN

September 2021

This thesis concerns the transformation of aged power systems to modern power systems that include microgrids with renewable energy sources and energy storage systems. The integration of renewable energy sources brings excellent opportunities to provide better reliability and efficiency. The aim of this dissertation is to maintain the supply-demand balance in microgrids while minimizing the cost in real time operation. A microgrid energy management system that can optimize the dispatch of the controllable distributed energy resources in grid-connected mode of a pilot microgrid on a university campus in Malta was developed to achieve this goal. Designing intelligent method for the real-time energy management of the stochastic and dynamic microgrid is the primary goal of this research. Moreover, the detailed mathematical models of the network model and of the technical model are considered for the economic and environmental operation of the microgrid system to solve the optimization problem under more real-world conditions. The objective is to minimize the total daily operation costs, which include the degradation cost of batteries, the cost of energy bought from the main grid, the fuel cost of the diesel generator, and the emission cost. Q-learning algorithm is adopted to solve the sequential decision subproblems. The proposed algorithm decomposes a multi-stage mixed-integer nonlinear programming (MINLP) problem into a series of single-stage problems so that each subproblem can be solved using Bellman's equation. A predictive control framework is also proposed to provide optimal operation with minimum cost. This method allows the consideration of operational cost values, demand with uncertainty, generation units' profiles with uncertainty, and constraints related to the network model and technical model.

Keywords: Microgrid, Rolling horizon control, Reinforcement learning, Energy management

ÖZET

AKILLI MİKRO-ŞEBEKELERDE KONTROL STRATEJİLERİNİN GELİŞTİRİLMESİ

Yeliz YOLDAŞ
Elektrik ve Bilgisayar Mühendisliği Anabilim Dalı Doktora
Tez Yöneticisi: Doç. Dr. Ahmet ÖNEN
Eylül-2021

Bu tez, eskimiş güç sistemlerinin yenilenebilir enerji kaynakları ve enerji depolama sistemleri ile mikro şebekeleri içeren modern güç sistemlerine dönüşümü ile ilgilidir. Yenilenebilir enerji kaynaklarının belirsizliği ve kesintili doğası, elektrik şebekesinin istikrarını ve kalitesini düşürebilir. Bu nedenle, bu tezin amacı, gerçek zamanlı çalışmada minimum maliyetle mikro şebekede arz-talep dengesini sağlamaktır. Bu amaca ulaşmak için Malta'daki bir üniversite kampüsünde pilot bir şebekeye bağlı mikro şebekenin kontrol edilebilir dağıtık enerji kaynaklarının çıkışlarını optimize edebilen enerji yönetim sistemi geliştirilmiştir..

Stokastik ve dinamik mikro şebekenin gerçek zamanlı enerji yönetimi için akıllı sistem tasarlamak, birincil hedefe ulaşmanın en önemli parçasıdır. Ayrıca, optimizasyon problemini daha gerçek dünya koşullarında çözmek için mikro şebeke sisteminin ekonomik ve çevresel çalışması için şebeke modelinin ve teknik modelin ayrıntılı matematiksel modelleri düşünülmüştür. Buradaki optimizasyon problemindeki amaç, bataryanın degradasyon maliyetini, ana şebekeden satın alınan enerjinin maliyetini, dizel jeneratörün yakıt maliyetini ve emisyon maliyetini kapsayan toplam günlük işletme maliyetlerini en aza indirmektir. Sıralı karar alt problemlerini çözmek için Q-öğrenme algoritması kullanılmıştır. Önerilen algoritma, çok aşamalı Tamsayılı Karışık Doğrusal Olmayan Programlama (TKDOP) problemini tek aşamalı probleme serisine ayırıştırır, böylece her bir alt problem Bellman denklemi kullanılarak çözülebilir.

Ayrıca, minimum maliyetle optimum çalışmayı sağlamak için bir öngörülü kontrol metot önerilmiştir. Bu yöntem; işletme maliyet değerlerini, değişkenlik gösteren talebi, belirsizlik içeren üretim elemanlarının profillerini ve şebeke & teknik model ile ilgili kısıtlamaların dikkate alınmasını sağlamaktadır.

Anahtar kelimeler: Mikro şebeke, Yuvarlanan ufuk kontrolü, Pekiştirmeli öğrenme, Enerji yönetimi

Acknowledgements

First of all, I would like to express my deepest gratitude to my advisor Assoc. Prof. Ahmet ÖNEN for his helpful advice and valuable assistance throughout the doctoral study. I am eternally grateful for his endless patience, support, and encouragement.

I would like to give special thank you to Assist. Prof. Selçuk Gören who helped me to carry out this thesis. I am most grateful for the opportunity he gave me to work together, and also for his valuable comments and useful discussions.

With the same level of gratitude, I would also like to thank Prof. İrfan Alan, who was a member of my thesis committee throughout this thesis, for his valuable comments and understanding.

I am also grateful to the committee members, Prof. Ferhat Daldaban and Assist. Prof. Nurettin Üstkoyuncu. Thank you for your time and valuable comments.

I would also like to thank all my colleagues who directly and indirectly help me for their unlimited support and encouragement.

Finally, I owe a deep gratitude to everyone who supported and encouraged me in my private life. I am especially grateful to my precious mother, father, and sisters for their endless support throughout my life.

TABLE OF CONTENTS

1. INTRODUCTION	1
1.1 RESEARCH MOTIVATION AND PROBLEM STATEMENT.....	5
1.2 RESEARCH OBJECTIVES AND CONTRIBUTIONS	6
1.3 DISSERTATION OUTLINE	7
2. ENHANCING SMART GRID WITH MICROGRIDS: CHALLENGES AND OPPORTUNITIES	9
2.1 MICROGRID TO SMART GRID.....	9
2.2 ARCHITECTURAL MODEL OF FUTURE SMART GRID	11
2.2.1 AC microgrids.....	11
2.2.2 DC microgrids	11
2.2.3 Hybrid AC-DC microgrids	11
2.3 FUNCTIONS OF SMART GRID COMPONENTS	12
2.3.1. Smart device interface components	12
2.3.2 Advanced forecasting.....	19
2.3.4 Control of generation units.....	20
2.3.5 Control of storage units	20
2.3.6 Data transmission and monitoring	21
2.3.7 Power flow and energy management.....	24
2.3.8 Vehicle to grid (V2G).....	25
2.4 CHALLENGES AND OPPORTUNITIES	26
2.4.1 Technical challenges.....	26
2.4.2 Regulation challenges.....	27
2.4.3 Smart consumer	27
2.4.4 Opportunities in microgrid	28
2.5 CONCLUSION.....	29
3. OPTIMIZATION-BASED CONTROL STRATEGIES FOR ENERGY MANAGEMENT SYSTEMS IN MICROGRIDS	30
3.1 LITERATURE REVIEW.....	30
3.2 MIXED INTEGER NONLINEAR PROGRAMMING	33
3.3 ROLLING HORIZON CONTROL	34
3.4 REINFORCEMENT LEARNING.....	35
3.3.1 Optimal value function and optimal policy.....	37
3.3.2 Markov decision process (MDP)	38
3.3.3 Bellman Equations.....	38
3.3.4 Q-learning.....	39
4. DYNAMIC ROLLING HORIZON CONTROL APPROACH.....	41
4.1 INTRODUCTION	41
4.2 MICROGRID MODEL DESCRIPTION	43
4.2.1 Battery Model	44
4.2.2 Diesel Generator (DG).....	45
4.2.3 Main grid.....	45
4.2.4 AC Power Flow.....	46
4.2.5 Objective Function.....	46

4.3 ROLLING HORIZON CONTROL APPROACH	47
4.4 SIMULATION ENVIRONMENT & NUMERICAL ANALYSIS	49
4.4.1 <i>Simulation Environment</i>	49
4.4.2 <i>Numerical Analysis</i>	51
4.5 CONCLUSION	55
5. OPTIMAL CONTROL OF MICROGRIDS WITH MULTI-STAGE MIXED- INTEGER NONLINEAR PROGRAMMING GUIDED Q-LEARNING ALGORITHM.....	57
5.1 INTRODUCTION	58
5.2 MICROGRID MODEL DESCRIPTION	60
5.2.1 <i>Battery Model</i>	61
5.2.2 <i>Diesel Generator</i>	62
5.2.3 <i>Main grid</i>	63
5.2.4 <i>AC Power Flow</i>	63
5.2.5 <i>Emission Cost Calculation</i>	64
5.3 MDP MODEL FOR REAL-TIME SCHEDULING OF MICROGRID	64
5.3.1 <i>State Variables and Decision (Action) Variables</i>	65
5.3.2 <i>Objective Function</i>	65
5.4 PROPOSED OPTIMIZATION MODEL	65
5.5 NUMERICAL AND RESULT ANALYSIS	67
5.5.1 <i>Simulation Environment</i>	67
5.5.2 <i>Case Studies</i>	69
5.6 CONCLUSION	74
6. CONCLUSIONS AND FUTURE PROSPECTS	75
6.1 CONCLUSIONS	75
6.2 SOCIETAL IMPACT AND CONTRIBUTION TO GLOBAL SUSTAINABILITY.....	76
6.3 FUTURE PROSPECTS	77

LIST OF FIGURES

Figure 1.1 Total gross electricity production, 1974-2018	1
Figure 1.2 World electricity final consumption, by sector, 1974-2018.....	2
Figure 1.3 World electricity generation mix 1971-2018	2
Figure 1.4 Energy related CO2 emissions, 1990-2019	3
Figure 1.5 Fuel shares of world electricity production, 2018.....	5
Figure 1.6 Annual net capacity additions by technology.....	5
Figure 2.1 Smart grid conceptual model.....	10
Figure 2.2 A general structure for hybrid microgrid	12
Figure 2.3 Smart grid with an energy storage system.....	15
Figure 2.4 Wind speed in Hokkaido Island, Japan	16
Figure 2.5 Frequency fluctuation at heavy load (conventional pitch controller).....	16
Figure 2.6 Frequency fluctuation at low load (conventional pitch controller)	17
Figure 2.7 Frequency fluctuation at heavy load (conventional and new pitch controllers)	17
Figure 2.8 Frequency fluctuation at low load (conventional and new pitch controllers)	18
Figure 2.9 Frequency fluctuation at low load (using ESS).....	18
Figure 3.1 Rolling horizon framework	35
Figure 3.2 Agent and environment interactions in reinforcement learning.....	36
Figure 4.1 Schematic diagram of microgrid	43
Figure 4.2 The flowchart of energy management process.....	48
Figure 4.3 Load demand and PV power generation for each building in stochastic case	50
Figure 4.4 Profile of electricity price.....	51
Figure 4.5 Percentage of the optimality.....	52
Figure 4.6 Behaviour of the SOC value and power outputs of the assets at each time step, respectively	54
Figure 5.1 Schematic diagram of microgrid.	61
Figure 5.2 Flowchart of training process.	66
Figure 5.3 Profiles of load demand.....	67
Figure 5.4 Profile of electricity price.....	69
Figure 5.5 Output power of all sources for Case 1	70

Figure 5.6 Output power of all sources for Case 2	71
Figure 5.7 Output power of all sources for Case 3	72

LIST OF TABLES

Table 1.1 Overview of main potential impacts on the electricity system due to climate change	4
Table 4.1 Parameters of distribution lines	49
Table 4.2 Parameters of DG	49
Table 4.3 Parameters of lithium-ion battery	50
Table 4.4 Performance comparison for deterministic case	52
Table 4.5 Performance comparison for stochastic case with different noises	53
Table 4.6 Comparison of results of problem no. 1 with different DoD level	55
Table 5.1 Parameters of DG	68
Table 5.2 Parameters of lithium-ion battery	68
Table 5.3 Parameters of distribution lines	68
Table 5.4 Parameters of externality costs and emission factors of DG and main grid ...	69
Table 5.5 Simulation results of proposed algorithm compared with QL algorithm for Case 1	70
Table 5.6 Simulation results of proposed algorithm compared with QL algorithm for Case 2	72
Table 5.7 Simulation results of proposed algorithm compared with QL algorithm for Case 3	73
Table 5.8 Emission cost and daily energy cost comparison for three cases with SOC of 50%	73

LIST OF ABBREVIATIONS

ACD	Adaptive Critic Design
ADHDP	Action-Dependent Heuristic Dynamic Programming
ADP	Adaptive Dynamic Programming
AMI	Advanced Metering Infrastructure
CSMA/CA	Carrier Sense Multiple Access with Collision Avoidance
CHP	Combined Heat and Power
DER	Distributed Energy Resources
DG	Diesel Generator
DGS	Distributed Generator Sources
DMS	Data Management System
DP	Dynamic Programming
DoD	Depth of Discharge
DQN	Deep Q-Network
EMS	Energy Management System
ERGEG	European Regulators Group for Electricity and Gas
ESS	Energy Storage System
ETPS	European Technology Platform Smart Grids
GA	Genetic Algorithm
GAMS	General Algebraic Modelling System
GHG	Greenhouse Gas
HAN	Home Area Networks
ICT	Information and Communication Technology
IEA	International Energy Agency
LAN	Local Area Networks
MAS	Multi-Agent System
MCAST	Malta College of Arts, Science and Technology
MDMS	Meter Data Management System
MDP	Markov Decision Process
MG	Microgrid
MILP	Mixed Integer Linear Programming

MINLP	Mixed Integer Nonlinear Programming
MPC	Model Predictive Control
NAN	Neighborhood Area Networks
PEV	Plug-in Electric Vehicles
PCC	Point of Common Coupling
PLC	Power Line Communication
PSO	Particle Swarm Optimization
PV	Photovoltaic
RES	Renewable Energy Sources
RHC	Rolling Horizon Control
RL	Reinforcement Learning
SG	Smart Grid
SMI	Smart Metering and Infrastructure
SMES	Superconducting Magnetic Energy Storage
SOC	State of Charge
TD	Temporal Difference
V2G	Vehicle to Grid
VSI	Voltage Source Inverter
WAN	Wide Area Network
WSN	Wireless Sensor Networks

To my family

Chapter 1

Introduction

The demand for electricity has been exponentially increasing over the past several generations as humanity moves into a more technological world. According to the Electricity Information Overview 2020 report, the world gross electricity generation reached 26,730 TWh, 3.9% above the 2017 figure. Figure 1.1 compares the period between 1974 and 2018, with an average annual growth rate of 3.3%. Based on the same growth rate of 3.3%, it should also be pointed out that the world electricity final consumption increased from 5000 TWh to 22,315 TWh between 1974 and 2018, as shown in Figure 1.2 below. In 2018, consumption was 4.0% higher than in 2017 [1].

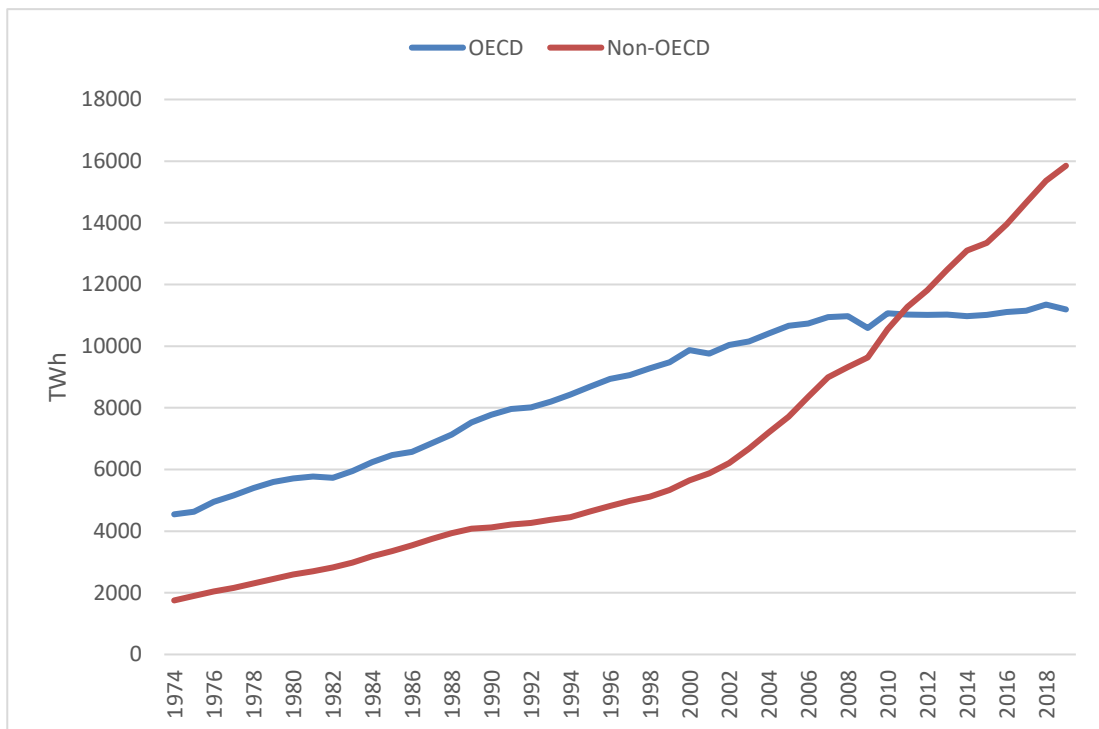

Figure 1.1 Total gross electricity production, 1974-2018 [1]

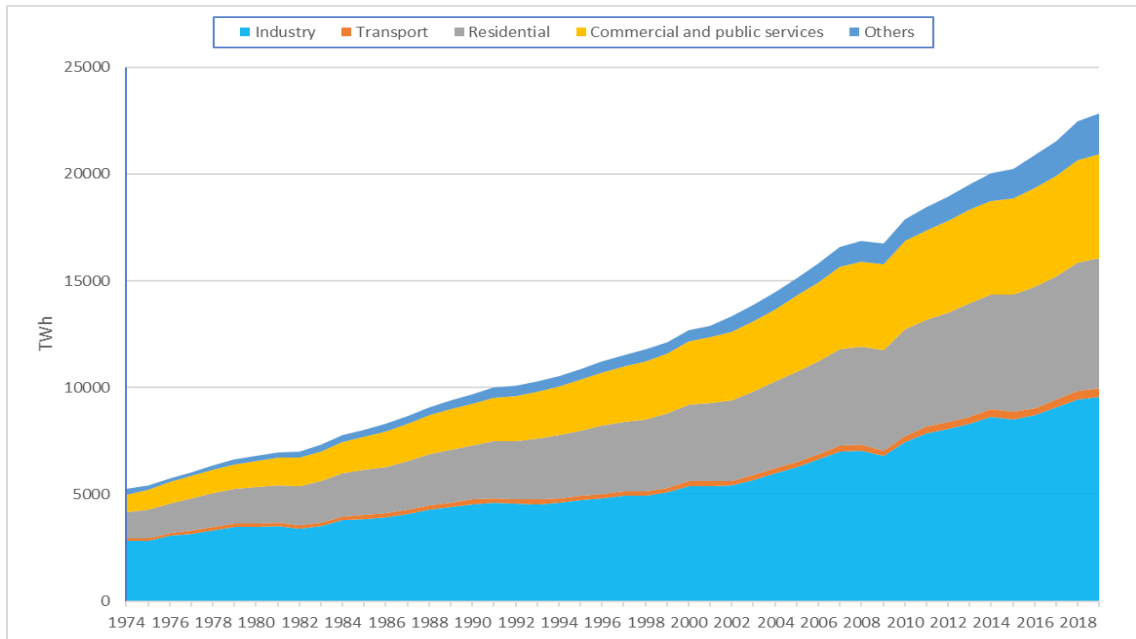

Figure 1.2 World electricity final consumption, by sector, 1974-2018 [1]

From Figure 1.3 below, it can be observed that electricity generation from coal (the top fuel in 2018 by far) constituted 38% of the total electricity generation. Renewable sources (including hydro, wind, solar, geothermal, biofuels, tidal and other sources) become the second fuel used for electricity generation, at 26% in 2018. Natural gas took third place, with 23% of the world gross electricity production in 2018. It can thus be inferred that 63.9% of electricity production was provided from fossil fuels in 2018 [2].

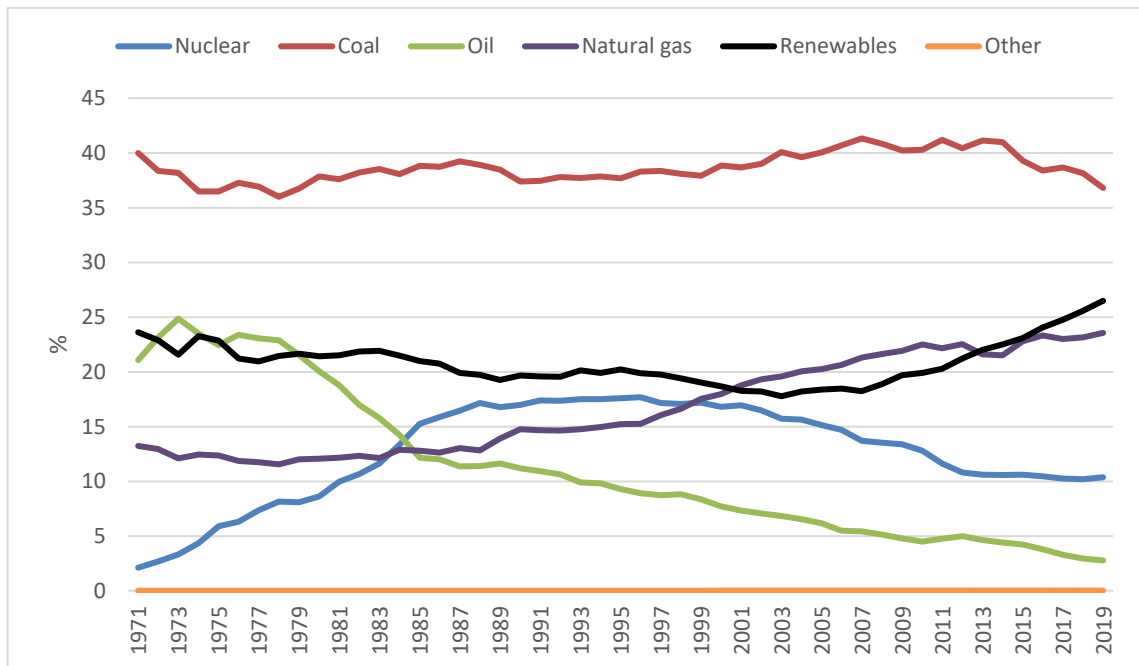

Figure 1.3 World electricity generation mix 1971-2018 [2]

Since more than half of the electricity generation has been provided by fossil fuels (according to Figure 1.4), the energy-based greenhouse gas (GHG) emission increased from 20.5 GtCO₂ to 33.3 GtCo₂ between 1990 and 2019. This rapid increase in energy-related emissions, which rose by approximately 2.5 times between 1990 and 2019, was mostly due to the energy consumption of countries other than countries with advanced economies [3].

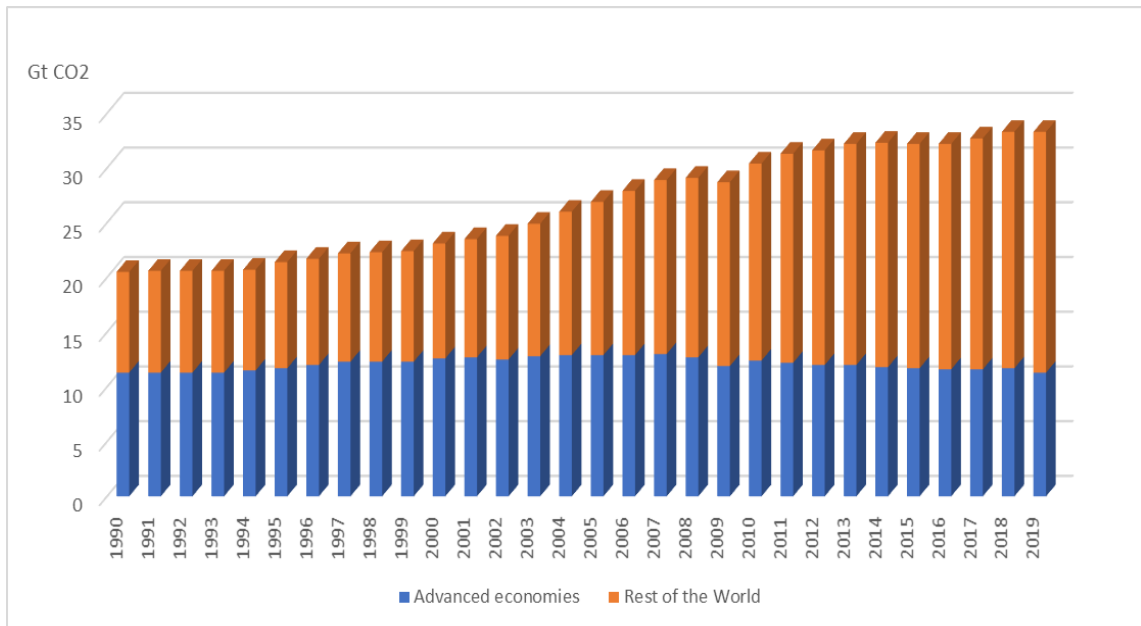

Figure 1.4 Energy related CO₂ emissions, 1990-2019 [3]

With the increase of GHG emission, climate change has become an increasing threat to electricity systems and directly affects every segment of the electricity network. Rising global temperatures and the escalation of extreme weather events can cause decreased efficiency in generation, transmission, and distribution systems and can also affect demand for cooling and heating. Table 1.1 below presents an overview of the major potential impacts on the electricity system caused by climate change [4].

Table 1.1 Overview of main potential impacts on the electricity system due to climate change [4]

Climate impact	Generation	Transmission and distribution	Demand
Rising global temperatures	<ul style="list-style-type: none"> • Efficiency • Cooling efficiency • Generation potential • Need for additional generation 	<ul style="list-style-type: none"> • Efficiency 	<ul style="list-style-type: none"> • Cooling and heating
Changing precipitation patterns	<ul style="list-style-type: none"> • Output and potential • Peak and variability • Technology application 	<ul style="list-style-type: none"> • Physical risks 	<ul style="list-style-type: none"> • Cooling • Water supply
Sea-level rise	<ul style="list-style-type: none"> • Output • Physical risks • New asset development 	<ul style="list-style-type: none"> • Physical risks • New asset development 	<ul style="list-style-type: none"> • Water supply
Extreme weather events	<ul style="list-style-type: none"> • Physical risks • Efficiency 	<ul style="list-style-type: none"> • Physical risks • Efficiency 	<ul style="list-style-type: none"> • Cooling

Clean energy transition is needed to combat the effects of climate change. Variable renewable energy sources (like wind and PVs) have become among the fastest growing and cheapest electricity resources in the world. Thanks to falling costs, variable renewable energy technologies are seen as the heart of the transformation from conventional forms of power generation to clean energy sources. The deployment and development of clean energy technologies is crucial to reduce carbon emissions and other pollutants caused by energy use, and also to contribute to economic development. As shown in the Figure 1.5 below, renewable energy sources are the second largest contributor to world energy production, at 25.2% in 2018 [5]. Looking at the annual capacity increase by technology between 2000 and 2018, it can be seen that the increase in capacity is gradually increasing. Net renewable capacity additions reached to 178 GW in 2018, of which around 85% was made by variable renewable energy sources as given in Figure 1.6 [6]. According to the IEA Stated Policies Scenario [7], low-carbon sources will provide more than half of total electricity generation by 2040. Moreover, the average annual share of variable renewables in total generation will reach 45% by 2040.

With the rapid growth of renewable energy, power system transformation is inevitable. Because variable renewable energy sources have different technical characteristics such as limited controllability and intermittent nature than conventional technologies, their integration into the power system poses new challenges.

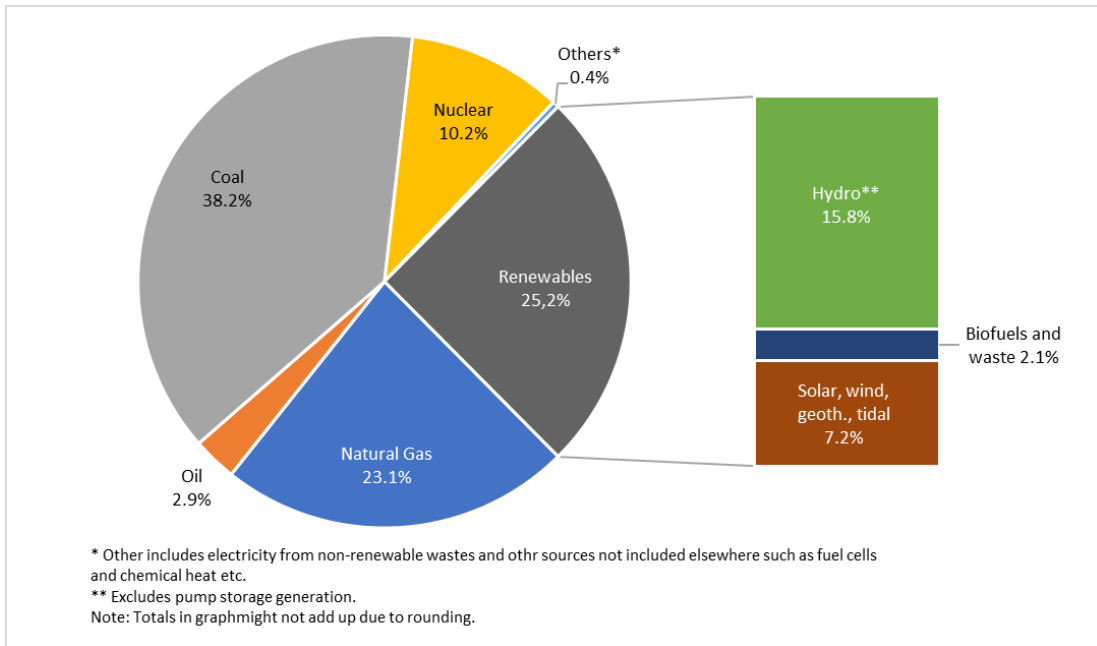

Figure 1.5 Fuel shares of world electricity production, 2018 [5]

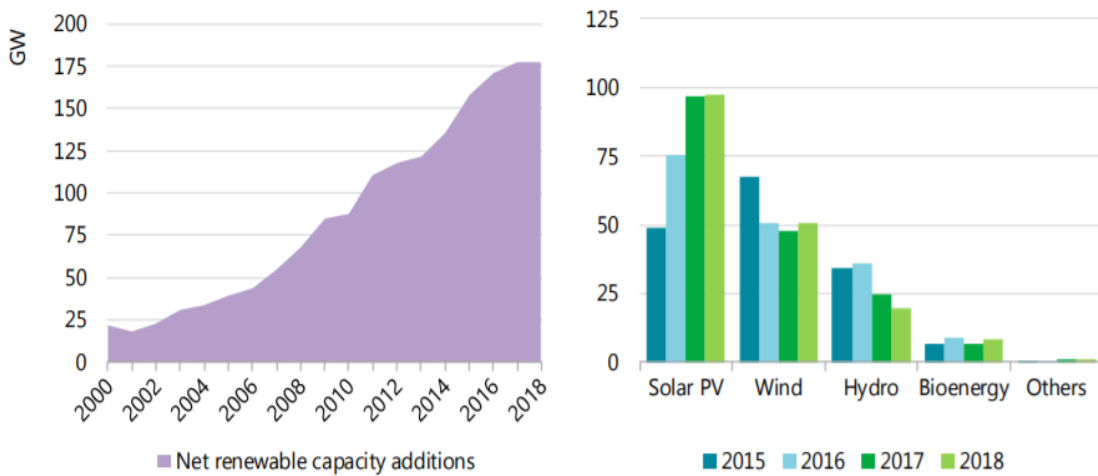

Figure 1.6 Annual net capacity additions by technology [6]

1.1 Research Motivation and Problem Statement

The modern world has been faced with a crisis of unsustainable energy. Although the primary source of this crisis has been an increase of the global energy demand, other reasons have contributed as well, namely: a diminished availability of primary energy sources and the aging of traditional transmission and distribution networks. These factors, taken in conjunction with the impact of global warming, has sparked the search for innovation regarding traditional grid architectures.

One such solution in the modern world is Distributed Generation Sources (DGS) of electricity, as this technology is highly efficient, protects the environment, reduces the loss of transmission and distribution, and supports the local power grid to improve system stability. In addition to this, DGSs are able to integrate with existing renewable energy sources, including wind, hydro, photovoltaic, and more. However, applying distributed generators is not without its drawbacks, as it has been prone to cause as many problems as it addresses. Instead of DGS technology on its own, a more efficient method of implementing the benefits of this technology is to implement a system which recognizes generation and its associated loads as a subsystem. This is also known as a “microgrid.”

One of the natural benefits of such microgrid (MG) technology is the ability to connect and/or disconnect from the grid whenever necessary. As such, microgrids provide improved reliability and offer a lower investment cost, and they are able to reduce emissions, improve the quality of power, and reduce the power losses of a distributed network. Despite the potential benefits, the development of microgrids suffers from several major challenges. One of the challenges is stability and reliability issues caused by the natural uncertainty of distributed energy resources (DERs). The management of the power system operation is quite complex because this instability and unreliability make it very difficult to maintain a balance between supply and demand of energy in real-time operation. When integrating renewable energy sources (RESs) into the power systems, the complicated systems become even more complex, rendering the management of power systems including DERs a real challenge. It is crucial to have appropriate energy management in place for the success of such complicated power systems. A microgrid energy management system (EMS) plays a critical role in the economic, sustainable, and reliable operation by providing the optimal coordination between conventional energy resources, RESs, energy storage systems (ESSs), and consumers [3].

1.2 Research Objectives and Contributions

The primary objective of this thesis is to develop a microgrid energy management system that can optimize the dispatch of the controllable distributed energy resources in a microgrid along the grid-connected mode of operation. Designing an intelligent method for the real-time energy management of the stochastic and dynamic microgrid is thus the primary goal. Moreover, the detailed mathematical model of the network is considered

for the economic and environmental operation of the microgrid system. Therefore, based on the objectives of this thesis, the main contribution of the research can be listed as follows:

- **A detailed mathematical model for the microgrid.** The thesis has proposed a detailed mathematical model by taking into account the constraints of the network model and technical model to operate the microgrid effectively.
- **Design of an energy management system under stochastic and dynamic environment.** The thesis has used an advanced control technique, rolling horizon control, to provide an online energy management system under a dynamic and stochastic environment. The proposed model is formulated as mixed integer linear programming (MILP).
- **Design of an intelligent energy management system.** The thesis has used machine learning algorithm to provide optimal operation, which includes a sequential decision-making process to overcome uncertainty in demand and overcome the problem arising from the integration of variable power generation units into the main grid.
- This work provides minimum energy cost and minimum emission cost by balancing the energy sources and demand within the microgrid, considering optimization requirements and all the constraints of the diesel generator, battery, photovoltaic system, demand, and network.
- **Using reinforcement learning (RL).** This thesis has proposed a Mixed Integer Nonlinear Programming (MINLP) guided Q-learning algorithm for smart microgrid operation, which improves Q-learning based optimization performance with large state-space.

1.3 Dissertation Outline

The remainder of the thesis is organized as follows:

Chapter 2:

A comprehensive literature review of microgrid is provided in this chapter. It represents background and detailed technical overview of microgrid and smart grid. The microgrid architecture and functions, existing technical and regulation challenges, polices and opportunities are presented in this chapter.

Chapter 3:

This chapter focuses on optimization-based control strategies for energy management systems in microgrids used in the literature. Moreover, the algorithms used in this study are explained in detail.

Chapter 4:

This chapter provides a real-time energy management system with rolling horizon control under deterministic and stochastic conditions. Deterministic and stochastic case studies are defined and simulated. The results were compared with the MILP and myopic approach to display how it copes with randomness of PV generation and demand.

Chapter 5:

A MINLP guided Q-learning algorithm has been proposed for smart microgrid operation, which improves vanilla Q-learning based optimization performance with large state-space. The proposed algorithm decomposes a multi-stage MINLP problem into a series of single-stage problems so that each subproblem can be solved. The proposed model has implemented three case studies with different objectives. Moreover, each case is operated under different battery operation conditions to investigate the battery lifetime. Finally, performance comparisons are carried out with a conventional Q-learning algorithm.

Chapter 6

A summary of the main conclusions of this thesis are provided. Future works are given.

Chapter 2

Enhancing smart grid with microgrids: Challenges and opportunities

Modern electric power systems are going through a revolutionary change. This is caused by an increasing demand of electric power worldwide, developing political pressure and public awareness to reduce carbon emission, incorporating large scale renewable power penetration, and the blending of information and communication technologies with the operation of power systems. The result of these was the establishment of the microgrid concept, which has undergone major development and changes over the last decade, recently boosted by smart grid technologies. The objective of this chapter is to present a detailed technical overview of microgrid and smart grid in light of present developments and future trends. First, the architecture and functions of microgrid are discussed. Following that, the smart features of the microgrid are mentioned to demonstrate the recent architecture of smart grids. Finally, the existing technical challenges, communication features, policies and regulation are discussed from the perspective of visualizing the future smart grid architecture.

2.1 Microgrid to smart grid

Smart grids [8] greatly benefit the progress of electricity grids. According to The European Regulators Group for Electricity and Gas (ERGEG), based on the definition from the European Technology Platform Smart Grids (ETPS), a smart grid is an electricity network that can integrate the behavior and actions of all users connected to it – generators, consumers and those that do both – in order to ensure an economically efficient, sustainable power system with low losses and high levels of quality and security of supply and safety [9]. The concept of the smart grid model can be briefly explained under several domains, as shown in Figure 2.1. Smart grids are characterized by the following [10]:

- Self-healing
- Consumer friendly
- Resistant to physical and cyber attacks
- Optimizes asset utilization
- Eco-friendly
- The use of robust two-way communications, advanced sensors and distributed computing technology
- Improve the efficiency, reliability and safety of power delivery and use.

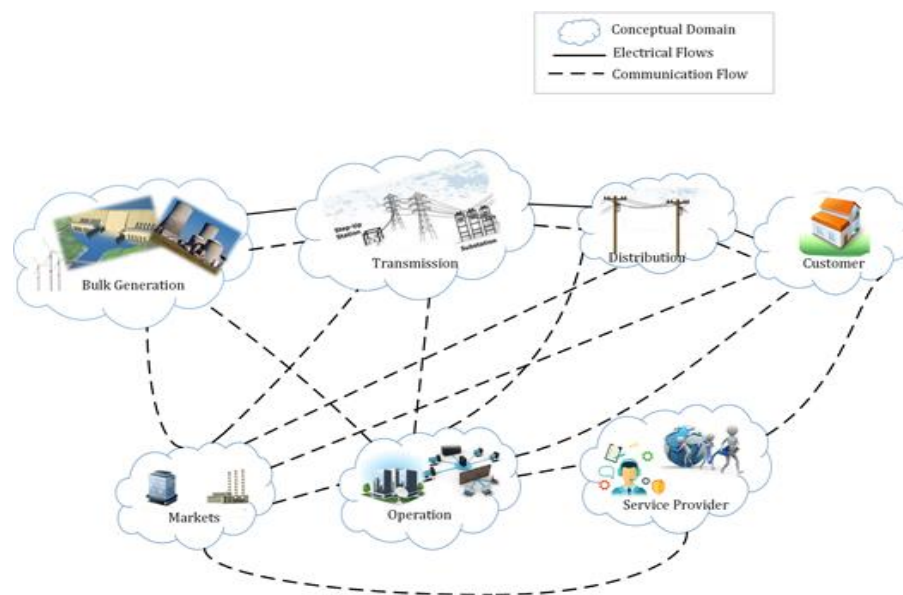

Figure 2.1 Smart grid conceptual model

Notwithstanding the many advantages, smart grid technology is faced with many obstacles. These include: bidirectional communication systems, integration to grids with renewable energy resources, ineffective utilization of the DGS, inadequate existing grid infrastructure, and storage. One of the methods to attain effective utilization of the DGS is to handle electricity generations, energy storages, and loads as a localized group [11].

Microgrids play a key role in the smart grid concept. These are pieces of the larger grid, which involve nearly all of components of the utility grid but are smaller in size. While smart grids take place at the larger utility level, such as large transmission and distribution lines, microgrids are smaller scale and can operate independently from the larger utility grid.

2.2 Architectural model of future smart grid

Microgrids can be classified into three main groups, depending on the way in which the AC and DC buses are connected. The proposed classification is as follows: AC-microgrids, DC-microgrids, and hybrid AC/DC microgrids.

2.2.1 AC microgrids

AC microgrids have a common AC bus which is generally connected to mixed loads (DC and AC loads), distributed generations, and energy storage devices. AC microgrids are easily integrated to conventional AC grids because most loads and the grid itself are AC. Therefore, it has more capacity, controllability, and flexibility. That said, DC loads, the DC sources, and energy storage devices are connected to the AC bus via the DC/AC inverter. This causes a significantly decrease in efficiency [12-13].

2.2.2 DC microgrids

In DC microgrids, a common DC bus is used to connect to the grid through an AC/DC converter. The operation principle of the DC microgrid is similar to the AC microgrid. Compared with AC microgrids, DC microgrids present a good solution to reduce the power conversion losses because they only need to convert power once connected to the DC bus. Therefore, DC microgrids have higher system efficiency, lower cost, and smaller system size. Moreover, DC microgrids are better compatible to integration of distributed energy resources (DERs) and offer better stability due to the absence of reactive power [14-15]. Different types of DC microgrids have been presented in the literature [12,16] (i.e. the monopolar, bipolar and homopolar type).

2.2.3 Hybrid AC-DC microgrids

Hybrid AC/DC microgrid is a combination of AC and DC microgrids in the same distribution grid. This type of microgrid facilitates the direct integration of both AC- and DC- based DGS, Energy Storage System (ESS), and loads and is shown in Figure 2.2. This architecture has advantages over both AC and DC microgrids, such as the minimum number of interface elements, higher reliability, easier integration of DERs, and the reduction of conversion stages, energy losses, and total costs. Moreover, when DGS,

loads and energy storage system (ESS) are directly connected either to the AC or DC networks, there is no need for synchronization of generation and storage units [17-18].

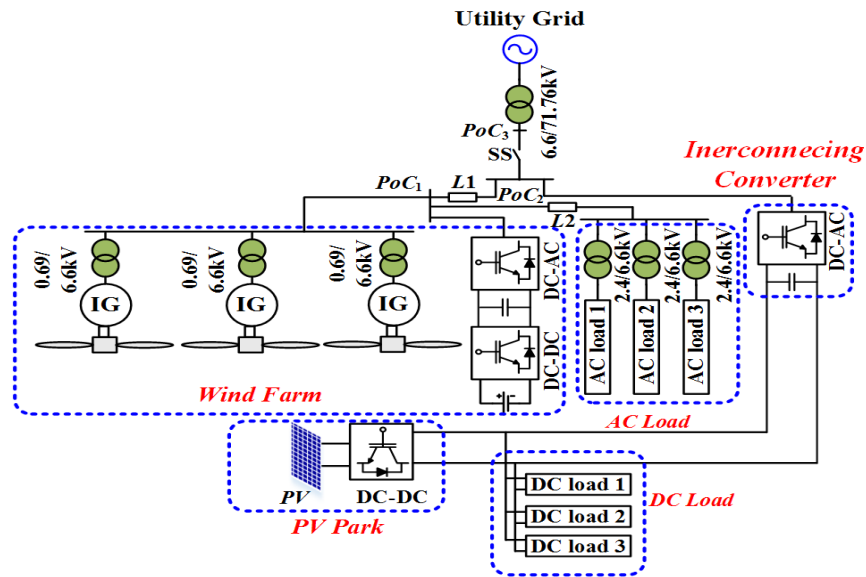

Figure 2.2 A general structure for hybrid microgrid

2.3 Functions of smart grid components

2.3.1. Smart device interface components

The elements that form a microgrid are described below:

2.3.1.1 Distributed Generators

Distributed generator units are the base of microgrids and located at or near the point of use. Two types of generation technologies can be implemented into microgrid systems: renewable resources (such as solar photovoltaics (PV), wind, small hydro power, ocean) and non-renewable resources (such as reciprocating engines, gas turbines, modern Combined Heat and Power (CHP)) [14,19].

Most of the distributed generator technologies require a power electronics interface in order to convert the energy into grid-compatible AC power. The power electronics interface contains the necessary circuitry to convert power from one form to another [20]. These converters may be a single-stage converter (DC-AC converter) or a double stage converter (DC-DC and DC-AC converter). The converter contains the necessary output

filters (L, LC, LCL, and LCL with damping resistor), connected in series with the converters improving harmonic performance at lower switching frequencies [21].

Distributed generation for a microgrid must be properly selected according to the characteristics and cost of the different technologies [13].

2.3.1.2 Energy storage devices

Energy storage devices can be classified into three categories: electrochemical systems (batteries and flow batteries), kinetic energy storage systems (flywheel) and potential energy storage (pumped hydro and compressed air storage). In [22-23], a detailed comparison of different energy storage devices can be found. Since pumped hydro storage and compressed air energy storage systems are large scale energy storage system, they are mostly used in the high power range for standard power systems, and hence, are not suitable for small-scale renewable energy systems [24].

Energy storage devices in microgrid applications may improve power imbalance, power quality, reliability and stability between loads and distributed generated resources output. More suitable energy storage devices can be determined according to the characteristic of loads and the distributed energy resources. Some key energy storage technologies available for MG applications are summarized as follows:

- Batteries are one of the most used energy storage devices. They are classified as lead acid, nickel cadmium (Ni-Cd), nickel metal hydride (NiMh) and lithium-ion (Li-on) batteries. Lead acid batteries are suitable for storing energy for long periods of time although they have a relatively poor performance and limited cycle life (1200–1800 cycles). When Ni-Cd batteries are compared with lead acid batteries, Ni-Cd batteries have longer cycle life, higher energy densities, and lower maintenance. Still, it features a major hindrance in its high initial capital cost. NiMh batteries have more energy density than Ni-Cd batteries (approximately 25–30% more) with equivalent lifecycle as lead acid batteries. The highest energy density is found in Li-on batteries compared to lead acid, Ni-Cd, and NiMh batteries, but the investment cost and limited life cycle are the main drawbacks of Li-on batteries [24-25]. Reference [26] proposed that a battery storage system be integrated into solar PV systems to mitigate the negative impacts of PV integration. Analyses performed by Simulink and Homer have been done to assess different battery storage systems from a techno-economic point of view in [24].

- Flywheel energy storage devices have long life cycles, as well as high energy and power density. Despite that, the drawback of flywheel energy storage is that they are inclined to have high friction losses. They can be used to mitigate the fluctuations in power generated by wind and solar systems [22]. Flywheel storage systems coupled with diesel generator are used in the studies of [27-28] to provide UPS service to the critical loads.
- Supercapacitors (also known as ultracapacitors or electric double layer capacitors) are based on the characteristics of the capacitor and electrochemical batteries without a chemical process. The main difference between capacitors and supercapacitors is the use of a porous membrane which provides ion transfer between two electrodes, thus electrical energy can be stored directly, causing a very low response time [29]. Moreover, its capacitance and energy density values can be hundreds to thousands of times larger than that of capacitors. When compared with lead acid batteries, supercapacitors have lower energy density but also have higher power density, longer lifecycles, and better energy efficiency (about 75–80%). The most important disadvantage of this technology is their high cost, about five times more expensive than lead acid batteries [25]. The research of Molina [30] and Brando [31] reported that supercapacitors are a good choice to mitigate the inherent natural fluctuations of intermittent renewable sources, such as wind and waves.
- Superconducting magnetic energy storage (SMES) systems have very long-life cycles (tens to thousands of cycles), very high efficiency (up to 95%), very fast response time, and high implementation cost. Possible applications are power factor improvement, frequency regulation, transient stability, and power quality improvement [32-33]. In study of Nguyen [34], SMES integrated with wind power was used to control the frequency and voltage of the microgrid in island mode. When the microgrid operates in the grid-connected mode, the SMES system is used to provide a constant power flow at point of common coupling (PCC) to overcome the fluctuations in power arising from the wind power.
- One of the commercially available flow batteries is the Vanadium Redox Battery (VRB). It has many advantages over many traditional battery energy storage systems (BESS), such as a long lifecycle, low maintenance, independent power and energy capacity, quick charge and discharge response, and high efficiency. However, the initial operating and maintenance costs are still relatively high in

comparison to BESS [29]. The current literature on VRB-based microgrids is limited, since this technology has been commercialized recently [34-35].

To demonstrate the importance of ESS on a smart grid, a case study has been made, based on the model shown in Figure 2.3 below. A 6.0 GW power system on the Hokkaido Island of Japan, which consists of hydro, thermal, and nuclear generators, is scaled down to 100 MW. Then a renewable energy park, consisting of wind and/or a photovoltaic system, is connected to the power system considering a maximum renewable power penetration of 10% of the original power system capacity. The original model shown in the study of Muyeen [36] is modified to show the effect of a high penetration of renewable energy on the modern smart grid and a path forward to overcome grid code barriers using storage technology.

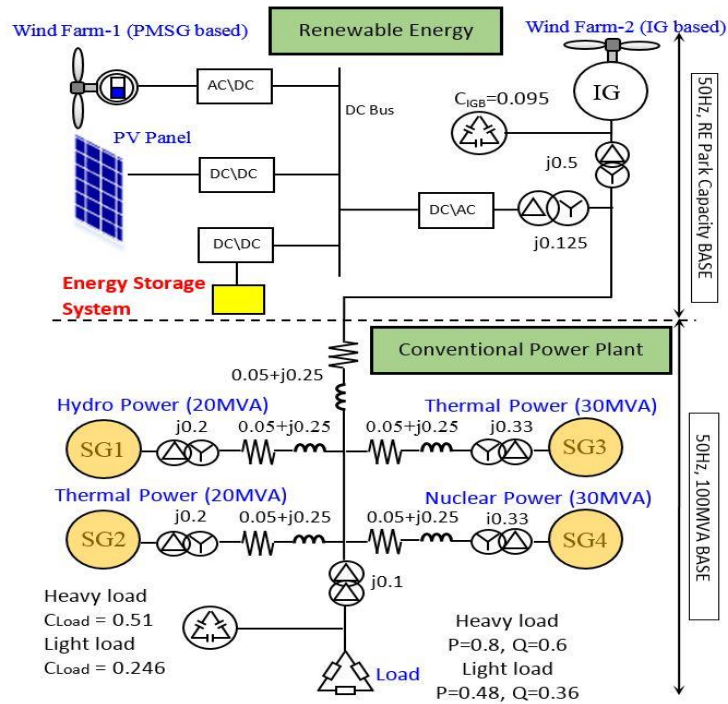

Figure 2.3 Smart grid with an energy storage system

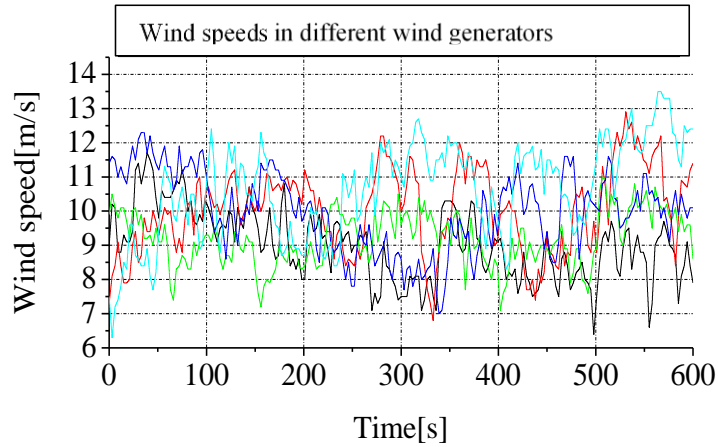

Figure 2.4 Wind speed in Hokkaido Island, Japan

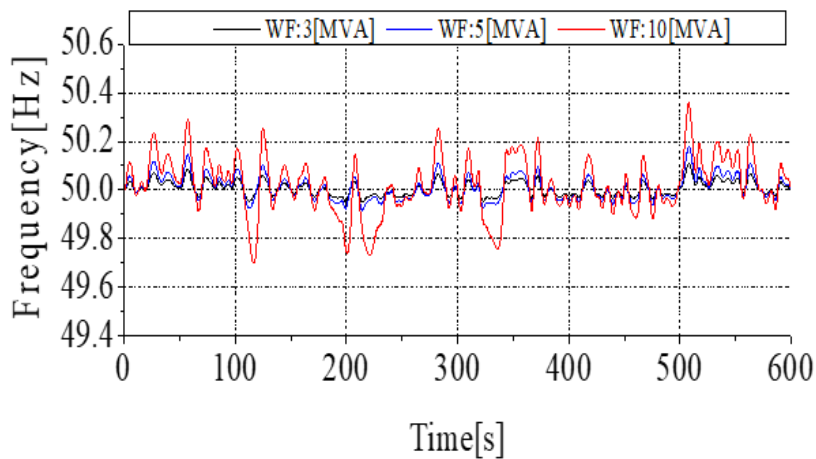

Figure 2.5 Frequency fluctuation at heavy load (conventional pitch controller)

The wind turbines are equipped with advanced pitch controllers [37] which can smooth the power going to the line when generated power is greater than the reference power produced from a low pass filter (i.e., the advanced pitch controller works even at wind speed lower than rated speed). The conventional pitch controller only works once the wind speed is above the rated speed. Figure 2.4 shows the different wind speed for different wind generations of two wind farms that were shown in Figure 2.3. Figure 2.5 and Figure 2.6 show the frequency fluctuations levels for different wind power penetration levels at high and low load conditions when only a conventional pitch controller is used. It is seen that when the wind power penetration level is maximum, the frequency fluctuation increases. However, when the advanced pitch controller is used, the frequency fluctuation is within the acceptable range for high load conditions, as shown in

Figure 2.7. Figure 2.8 shows that the advance pitch controller does not effectively control the frequency at a low load condition. However, when an ESS is used in the smart grid (Figure 2.3), the frequency can be maintained at the rated value, as shown in Figure 2.9. In this study, an energy capacitor system is used as ESS. Therefore, ESS will play a vital role in future smart grid operation, though the cost and lifecycles of ESSs remain the primary challenges.

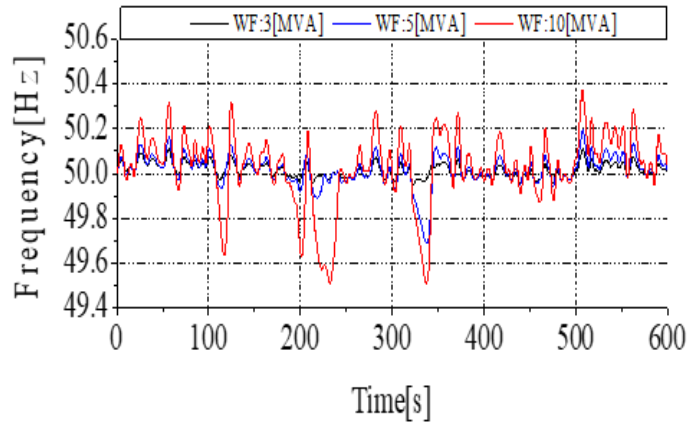

Figure 2.6 Frequency fluctuation at low load (conventional pitch controller)

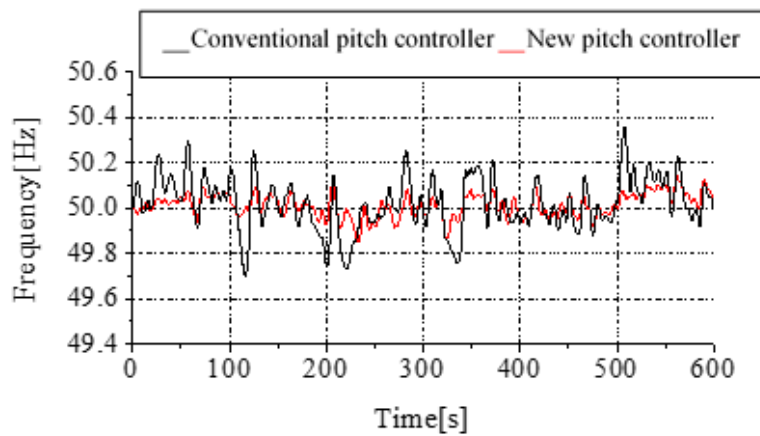

Figure 2.7 Frequency fluctuation at heavy load (conventional and new pitch controllers)

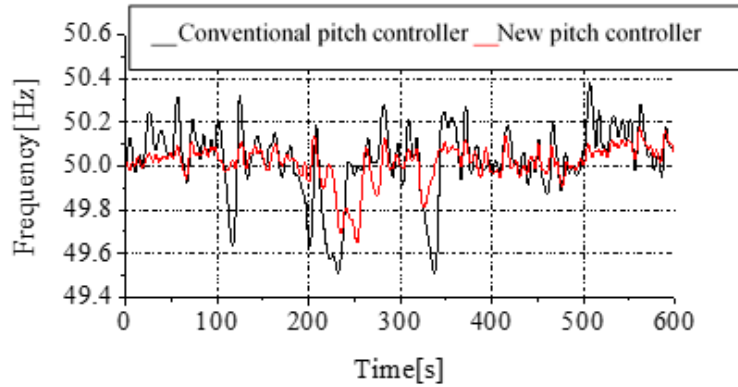

Figure 2.8 Frequency fluctuation at low load (conventional and new pitch controllers)

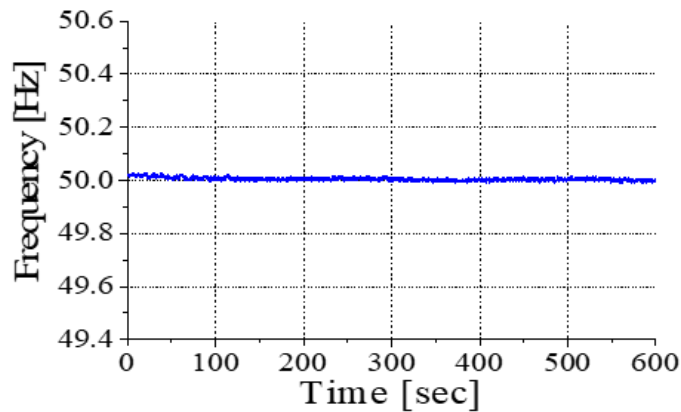

Figure 2.9 Frequency fluctuation at low load (using ESS)

2.3.1.3. Loads

Microgrids can supply electrical energy to different types of loads such as residential, commercial, and industrial. These loads can be categorized into two sections: critical load and noncritical loads. In general, commercial and industrial users are defined as critical loads, which require a high degree of power quality and reliability, while most of residential loads are considered non-critical loads, which require a lower service quality [13]. The load classification provides the advantages listed below while obtaining the desired operation, stability and control [38]:

- the load/source operation strategy required to meet the net active/ reactive power in grid-tied mode, and stabilization of the voltage and frequency in island mode,
- improved power quality and reliability of critical and sensitive loads,
- reduction of peak load to enhance the DER ratings,

- maintaining the desired operation and control.

2.3.2 Advanced forecasting

2.3.2.1 Demand (load) forecasting

Demand (load) forecasting [39-40] plays a crucial role in smart grids. The aim of demand forecasting is to accurately predict future energy requirements of a system for a specific period of time. That prediction helps unit commitment strategies to match demands and generations. Since demands depend on the weather conditions and activities of customers, predictions may be hourly for the next 24/48 hours for the operation process and may be for 20 to 50 years for planning purposes [41]. Many methods for demand forecasting are introduced in the literature. These methods can be classified into two sections: i) statistical based methods and ii) artificial intelligence (AI) based methods. Statistical based methods include Auto Regressive (AR) [42], Moving Average (MA) [43], Auto Regressive Moving Average (ARMA) [39], and Auto Regressive Integrated Moving Average (ARIMA) [44]. Some of the artificial intelligence-based forecasting models are Artificial Neural Network (ANN) [45], Grey-Back Propagation (GBP) Neural Network [46], Improved Variable Learning rate Back Propagation (IVL-BP) [47], Support Vector Machines (SVMs) [48], Least Squares-Support Vector Machine (LS-SVM) Algorithm [49], Particle Swarm Optimization (PSO) [50], and Fuzzy Logic (FL) [51].

2.3.2.2 Electricity price forecasting

Electricity price forecasting may be important in real time electricity markets. Extreme difference between the agreed cost and the cost of power to be sold can lead to huge financial losses or even bankruptcy [52]. In the literature, Motamedi [53] and Zhou [54] investigated the relationship between electricity price and demand.

2.3.2.3 Wind and PV production forecasting

The output power of renewable energy sources depends on several variables, such as weather and location. Accurate forecasts of wind and PV output power can alleviate negative impacts on the required spinning reserves for reliable operation of the grid. They reduce the total cost of integration of renewable energy into the grid [55]. The methods used to forecast wind and PV [56] production are partly similar to demand forecasting methods [55]. For instance, in the literature, the methods of SVM [57-58], vector auto regression theory [58], and the Bayesian Method with Monte Carlo [59] are used for PV.

2.3.4 Control of generation units

Smart grid technologies can include large amount of different DERs that are connected to a grid either directly or via a power electronic interface. The voltage source inverter (VSI) is connected to the grid as an interface to contribute to the proper adjustment of the grid voltage and frequency [60]. In the literature, while some authors classify VSI-based DGS interfaces as two groups, it is categorized into three groups by the other researchers. In this review study, these controllers were investigated under two domains related to their former classification: grid-forming and grid-following. A grid forming controller is responsible for voltage control between DGS units and loads. A grid-following controller is generally used in current-control mode to maximize obtained power from DGSs. This control strategy is the most widely used for DGS units, with the most common used grid-following techniques being synchronous reference frame (dq) and stationary reference frame ($\alpha\beta$) [21, 61-62]. The authors in [63] proposed a passivity-based control technique to improve system stability of DGSs. In the research of Vandoorn [64], unbalanced mitigation is investigated by using symmetrical component transformation for different types of grid-following controllers.

Besides the voltage and current control, DGSs must also regulate the active and reactive powers. The most used methods in smart grids are the Q/f and P/V droop controllers. When the Q/f droop controller is used for reactive power compensation, the active power controller uses a P/V droop control [65-66].

2.3.5 Control of storage units

Energy storage devices are an essential component of microgrids, which effectively balance power between renewable energy resources and loads. Specific charge/discharge control strategies are needed to achieve this objective. In the literature, different control strategies are available. The authors in [67] explained how to improve the wind output power rate using fuzzy control for an energy storage system on a wind farm. Other strategies include: hysteresis current control, neural network, PI and PID control, sliding mode control, H-infinity control, and the Monte Carlo simulation method [25, 68-69].

2.3.6 Data transmission and monitoring

2.3.6.1 Smart Metering Infrastructure (SMI)

Smart metering and infrastructure (SMI), which is also called advanced metering infrastructure (AMI), provides bidirectional communication for smart grids. The SMI consists of the integration of smart meters, a communication system, hardware and software that enable the measurement, gathering, storage, analysis, and usage of energy between the smart meter and utility or between the smart meter and customer [70-71].

- *Smart meter*: Smart meter is the advanced new generation of meters, which measures the real-time consumption of energy, record and store this measurement at predefined time intervals. It also has the ability to transfer the bidirectional communications of data. Thus, data transfer is realized not only from the smart meter to the meter data management system (MDMS) but also from the MDMS to the smart meter [72-73]. In [74], authors investigated the relationship between electricity consumers and smart meters and formed a report at the end of 2012 for Romania. This study demonstrated that smart meters are user-friendly and profitable for customers, and that it is important to devote close attention to the customer in terms of acceptability and affordability of the smart meters.
- *Wide area network (WAN)*: Wide area network (WAN) provides communication between the smart grid and utility grid, which collects data from multiple neighborhood area networks (NANs) and sends it to control center [75]. It connects the highly distributed smaller area networks that serve the power systems at different locations. It consists of two types of networks: backhaul and core network. A variety of technologies, such as WiMAX, 4G, and PLC, can be used in WAN networks. The WAN can cover an area over thousands of square miles, so data transfer rates may be up to 10–100 Mbps [76].
- *Home (local) area network (HAN/LAN)*: Home (local) area networks (HAN or LAN) connect to in-home smart devices and appliances such as plug-in electric vehicles (PEVs), programmable communicating thermostats, in-home displays (IHD) and distributed energy generation facilities [72-73]. Typically, HANs need to cover areas of up to 200 m² and support speeds 10 to 100 kilobits per second (kbps) [85]. One important component of HAN is the IHD that measures how much power is consumed and displays the real-time energy price to the customers.

The IHD also allows the consumer to customize their power usage profile in order to minimize their electricity bill.

- *Neighborhood area networks (NANs)* NANs are an important component of the communication network infrastructure that connects to smart meters in the customer domain and some field gateways in the distribution domain [77]. The NANs are used for data collection from smart meter to exchange energy data and control information between other components. This network can be designed based on wired and wireless communication technologies such as WiMAX, 3G and 4G. With these technologies, it covers long distances between one to ten square miles and the data rate is around 10–1000 Kbps [76].
- *Meter data management system (MDMS)*: A meter data management system (MDMS) is a system or an application which imports, verifies, edits and processes on the AMI data before making it available for billing such analysis [78].

2.3.6.2 Communication systems

Communication technologies are a key feature of smart grids, allowing them to be implemented in the real world. The chosen communication technologies have to be cost efficient and should provide a good transmittable range, better security features, bandwidth, power quality, and with the least possible number of repetitions [72]. They can be classified into two categories: wired technologies and wireless technologies.

- *Wired technologies*: Wired technologies may include three systems: Power line communication (PLC), Optical communication and Digital Subscriber Lines (DSL). The PLC system is a popular method for communication, which consists of introduction of the modulated carrier over the power line cable in order to provide bidirectional communications [79]. The power line cable is used in both energy transmission and data communication. In a typical PLC network, smart meters are connected to the data concentrator through power lines. Data is transferred to the data center via cellular network technologies [71]. PLC systems use the existing communication infrastructure. Thus, the cost of installation is lower than other communication system [80]. It can be classified into two categories: Narrowband PLC and Broadband PLC. Fiber optic communication technology has been widely connected to substations to provide communication between substations and control centers. It has many advantages, such as data transmission over long distances with a very high data rate, lower losses, and is

less expensive than traditional communication system. DSL is a high-speed communication technology which uses telephone lines. The most important advantages of DSL are low-cost, high data rate, and widespread availability [70-71, 81].

- *Wireless technology:* Wireless Sensor Networks (WSNs) are a crucial part of a smart grid that provide a highly reliable and self-healing power grid, as well as strong flexibility because a complex infrastructure construction is not needed [82-83]. A WSN can improve the efficiency and stability of a network. In the smart grid, the WSN collects and processes the specific and useful data in the target area and monitors control devices, allowing bidirectional information exchange, monitoring, control and maintenance in real time [84]. Wi-Fi (which is the family of IEEE 802.11 standards) is generally used for home and local area networking due to the simple and flexible access structures based on the Carrier Sense Multiple Access with Collision Avoidance (CSMA/CA) principle, operation in unlicensed 2.4 GHz and 5 GHz frequency bands, and availability low-cost radio interfaces [70]. The most popular among IEEE 802.11 standards are IEEE 802.11b and IEEE 802.11g. IEEE 802.11g supports a maximum data rate of 54 Mbps, while IEEE 802.11b supports a data rate up to 11 Mbps for indoor environments and 1 Mbps for outdoor environments. The latest release is the IEEE 802.11n that supports the highest data rates up to 150 Mbps [76]. In the smart grid, Wi-Fi is the key connection for all smart devices to access the Internet and manage their energy usage. Wi-Fi is a superior technology for the HAN of the Smart Grid in particular [85]. WiMAX (Worldwide Interoperability for Microwave Access), also known as the IEEE 802.16 standard, is a wireless broadband technology that supports thousands of simultaneous users over a large distance (up to 48 km) with high data rates of up to 70 Mbps. The WiMAX technology provides a reliable, high data rate and automatic network connectivity along with low overall installation costs and a large coverage area for smart grid applications [86-87]. GSM/GPRS technologies are a good option for communicating between smart meters and the utility, which transfers data and control signals over long distances. Global System for Mobile (GSM) is considered among the most secure communication networks. General Packet Radio Service (GPRS) employs wireless packets based on the GSM network. If the infrastructure exists, extra cost for building the communications infrastructure will not be needed. In smart grid

applications, it is mostly used for remote monitoring purposes. Satellite technologies are used in rural or geographically remote locations where other communication technologies are not available. While this technology has high cost, recent developments in satellite systems may open up new opportunities for the use of satellite communications in smart grids [70]. ZigBee is a wireless communication technology that has relatively low in power usage, data rate, complexity, and cost, based on the IEEE 802.15.4 standard. It is used for home automation, security systems, remote control, smart meters, healthcare, computer peripheral applications, and more [88-89].

2.3.7 Power flow and energy management

An energy management system (EMS) [90] is a control tool which controls the power flows among main grid, DERs and loads in order to provide stable, reliable, and sustainable operation of the microgrid and other operational goals such as minimizing costs and fuel consumption [91-92]. It is also responsible for system resynchronization during the transition between grid and island mode. Two main approaches can be identified for EMS: decentralized and centralized control, with various hierarchical controls [93-94].

2.3.7.1 Centralized controller

The centralized controller gathers all the measured data of all DERs in microgrid, and then adjusts the control variable for all the control equipment and sends them to central system [95]. This control is especially suitable for small scale MGs. However, this type of control has low reliability and redundancy. Other drawbacks of this control are that may cause several communication problems and that it requires a shutdown of the whole system in case of system maintenance.

From an economic point of view, centralized hierarchical control provides an efficient solution. The hierarchical control architecture depends on the type of microgrid or the existing infrastructure. In this case, a centralized hierarchical control scheme may consist of three controller layers: a) local controllers, b) a microgrid central controller (MGCC) [96], and c) distribution management system (DMS). The local controllers use local measurements to control voltages and frequency of the MG system without communication systems, because the communication system is often avoided over reliability concerns. A MGCC is available for each microgrid to interface with DMS. The

MGCC performs power management of the microgrid by determining the DERs' active power, load demand and storage requirements. The MGCC has two-way communication with the local controller (LC), which enables it to meet the utility requirements [97]. The overall grid demands and stability requirements are met at the data management system level [98].

2.3.7.2 Decentralized controller

The decentralized EMS enables independent control of the DER units and loads. This type of EMS is more suitable if users of the microgrid have different aims or a different operational environment. In this management system, all local controllers are connected with a communication bus. This bus is used to exchange data among each household or DGS [92]. Local controllers are no longer subject to a MGCC to determine the optimal power output in such a distributed system. Hence, this kind of structure significantly reduces the computational need and releases the stress on the communication network of the entire microgrid system [91].

The multi-agent system (MAS) approach can be seen as the best example of a decentralized energy management system [99]. This approach aims to turn large and complex systems into small and autonomy subsystems and uses AI-based methods (such as neural networks and fuzzy systems) to determine each DGS's operation point while improving the stability of the microgrid [92].

The decentralized based MAS has several advantages compared with centralized EMS. Since the MAS enables autonomous operation of the DGSs and uses the essential data from local controller, it reduces computation time. But the centralized control requires a significant flow of data to a central point [100-101]. Another advantage is plug and play capability. If a new DER is connected to the microgrid, a programmable agent in its control is provided without modifying the rest of the control. However, in centralized controls the MGCC has to be programmed when a new DER is connected [101].

2.3.8 Vehicle to grid (V2G)

Recently, vehicle to grid (V2G) technologies are more attractive to researchers of smart grid technology because it can improve efficiency, reliability, stability, and flexibility of the utility grid. Under this concept, electric vehicles can either be charged or discharged by providing power to the grid. In other words, either the utility grid can

absorb power from the V2G or the grid can send power back to the electric vehicle during charging. By providing power to the grid, this technology provides many benefits such as voltage and frequency regulation, spinning reserve, electrical demand side management, active/reactive power compensation, load balancing, and harmonic filtering. Furthermore, the electric vehicles would be used to store power produced by renewable energy resources [102-104]. V2G is also used both unidirectional and bidirectional applications [105]. K.M. Tan et al. [106] classify the V2G technology into two categories: unidirectional V2G and bidirectional V2G. This paper also presents the advantages and disadvantages, as well as optimization algorithms of V2G in a smart grid.

2.4 Challenges and opportunities

2.4.1 Technical challenges

2.4.1.1 Operation

Large mismatches which lead to a severe frequency and voltage control problems can occur between generation and loads because microgrid systems have the ability to transition from grid-connected mode to islanded mode [107-108]. If the connection and disconnection operations contain a large number of generation units at once, the "plug and play" capability can be a serious problem [109].

2.4.1.2 Components and compatibility

Because a microgrid may have many components (such as diesel generator, microturbine, fuel cell, CHP, energy storage devices, inverters, communication system, and control software), these components have different characteristics in their generation capacity, startup/shutdown time, operation cost/efficiency, energy storage charging/discharging rate, control and communication limits [107, 110].

2.4.1.3 Integration of renewable generation

The variability, unpredictability, and weather dependence of renewable energy resources are several of the major challenges for the integration of renewable generation to main grid. Therefore, the power output of these resources can vary abruptly, frequently imposing challenges on maintaining microgrid stability [10, 111-112]. Furthermore, one of the problems experienced is that the increasing renewable shares may cause congestion

in distribution networks [113]. Other problems may include the intermittency of renewable energy generation and the lack of a dispatch ability.

2.4.1.4 Protection

Microgrid protection is one of the most important challenges because it is not easy to design an appropriate protection system that must respond to both main grid and microgrid faults. That is because fault current magnitudes in the system depend on the microgrid operation mode, and may vary significantly between grid-connected and autonomous operation [114]. Traditional power systems have been designed and constructed with unidirectional fault current flow for radial distribution systems. However, the integration of DERs into the main grid with microgrids changes the flow of fault currents from unidirectional to bidirectional. The MG is interfaced to the main power system by a fast static switch to protect it in both modes of operation against all types of faults [108]. Several papers exist in the literature regarding microgrid protection schemes [115-117].

2.4.2 Regulation challenges

Regulation is a crucial topic to facilitate microgrid application, which provides guidance and allows DER penetration, integration, and main network connection. That said, regulations for microgrid implementation remain limited and prevent the proper use of microgrids. Moreover, interconnection rules between the MG and main grid are designed in order to standardize the process and manage the impacts of DERs integration without disturbing the functionality and safety of the main grid [107]. These rules must immediately disconnect with grid connection in case of any faults, blackouts, or other problems. However, the most consistent challenge of interconnecting microgrids with the main grid is the high connectivity costs caused by fee policies [118].

2.4.3 Smart consumer

Smart consumers are end users in the smart grid and take an active role in the problem of balancing demand with supply. They are mostly interested in decreasing their electricity bills, at maintaining their present levels of comfort (at least), and the availability and ease of use when faced with the volatile production capacity over volume and time [119]. With the consumers providing an active participation in the management of the demand, utilizing the intelligent information and communication technology

devices (ICT) has become common practice in domestic environments [120]. It is easy to envision that in the near future smart homes will be equipped with energy management systems in order to optimize the electricity consumption, to minimize costs and meet supply constraints, while at the same time maintaining the users' desired level of comfort [121].

2.4.4 Opportunities in microgrid

Some of the possible solutions featured in the literature for microgrid challenges are summarized below:

- Stability and reliability problems occurred due to the integration of renewable energy resources will be resolved with FACTS devices such as: static synchronous compensator (STATCOM), static VAR compensator (SVC), static series synchronous compensator (SSSC), and unified power flow controller (UPFC). Additionally, the harmonics resulting from power circuits will be mitigated by filters integrated with these devices [112]. The stability classifications and analysis methods for microgrid have been investigated in reference [122]. Other researchers also compiled the available methodologies to improve the stability of microgrids.
- The study of Zamani [123] presents a protection scheme for microgrids for both modes of operation based on microprocessor-based overcurrent relays and directional elements. Among other protection solution methods are: the adaptive protection system [124], symmetrical component theory [125], and differential protection [126].
- Fast static switches, fault current limiters, and energy storage devices can be used as external protection devices [127]. Fast static switches provide high-speed isolation for loads when transitioning from grid connected to islanded mode.
- Some authors investigate novel algorithms to minimize system costs [128-130]. The research of Khodaei [131] featured the use of the mixed integer programming optimization method to minimize total system costs, including investment and operation costs of candidate generation units, transmission lines, and microgrids. The paper of Ahn [132] proposed a decentralized voltage control algorithm, which was designed with two control layer. When the low control layer regulates the

power output and terminal voltage, the high-level controller minimizes power losses of the microgrid with its cost function concept.

- The study Papadimitriou [133] proposed a new islanding detection method (IDM) with an intelligent hybrid automatic transfer switch (HATS). HATS detects the operation modes of the microgrid and is able to manage grid status.

2.5 Conclusion

Power systems are faced with the challenge of providing efficient and reliable energy to customer. One of the major challenges is the increasing energy demand while primary energy supplies remain limited. This issue necessitates that more generation should be provided by distributed energy sources, which brings new problems such as uncertain power generation and intermittency. That problem also requires storage units to provide better power quality. A better way to solve the problems of energy demand, uncertain and non-sustainable power from renewable sources is to take a small subsystem approach to match the demand and supply balance. This was the key motivation for the development and expansion of microgrids.

The inherent characteristics of microgrids are that they provide flexibility to connect/disconnect from the grid when needed. This provides better reliability, lower investment cost, reduces emissions, improves power quality, and reduces the power losses of the distribution network. This review provides the technical development status of existing microgrid technology with its various functions and features. The microgrid architecture is categorized into three categories based on future smart grid vision: AC, DC, and hybrid microgrids.

The elements used in microgrids, control of power generation, forecasting techniques, data transmission and monitoring techniques have been reviewed as smart grid functions. While it is possible to implement microgrids with the usage of these functions, all issues cannot be solved. Finally, several other important issues in the implementation of microgrid are discussed. These are the technical, regulatory, and customer barriers, with opportunities of solving these barriers also being presented.

Chapter 3

Optimization-based Control Strategies for Energy Management Systems in Microgrids

3.1 Literature review

Elements in microgrids have some limits with minimum and maximum boundaries. Microgrids must operate within these limitations for reliable, stable, and cost-effective operation. PV units usually work at their maximum power output. Batteries also have limitations, such as charging and discharging speed limits. Excessive and/or frequent charging and discharging of the battery will shorten the lifespan of the battery and reduce its efficiency. Moreover, there are operational constraints for generation units, such as the limitations of ramp limits of diesel generators and starting power limits of generation. Pricing may also change depending on the energy trading situation with the main grid.

In the light of all above information, microgrids present great opportunity for composing a holistic system out of elements of different types and characteristics. These operational and technical constraints are taken into account to ensure proper energy management between conventional energy generation units, renewable energy sources, battery storage devices, and consumers. Therefore, the energy management system controls the output of power generation units and the charging or discharging operation of battery storage devices to maintain and optimize the power exchange, maximize energy efficiency, and minimize operational cost, while ensuring economic, environmental, and safe operation of the microgrid.

The uncertainty of DERs raises great challenges, especially in the real-time operation of the microgrids. This issue has attracted much attention in recent years and different methods such as classical methods (linear and nonlinear programming) [134-

136], meta-heuristic approaches [137], artificial intelligence methods [138-139], model predictive control (MPC) [140-141], stochastic, and the robust programming approach [142-144] have been proposed to optimize the effective operation of the MG.

To solve the challenge in MG operation as a deterministic optimization problem, many studies have been published in the literature. In the deterministic optimization model, output power of renewable energy sources (RESs) and load demand have not been taken into consideration as a factor of uncertainty. In the model, only forecasted outputs are taken into account to achieve the desired objectives. Since unexpected power changing in real time operation that effects the economic dispatch or ancillary services cannot be addressed effectively in the deterministic model, optimal control cannot be fulfilled properly. As a deterministic optimization algorithm, mixed integer linear programming (MILP) [135,145], deterministic MPC [146], rolling horizon control (RHC) [147-149], and adaptive dynamic programming (ADP) [150] have been used in the literature. Wei [151] proposed a mixed iterative ADP based on priori known load and electricity price rate.

To tackle the uncertainty problem, studies on the stochastic MG energy management [152-154] have increased. However, there are not enough studies in the field of stochastic optimization of MG, with a need for further improvement. The stochastic optimization algorithms (such as dynamic programming (DP) [155-157], approximate DP (ADP) [150, 158-159], and stochastic MILP [160-161], and MINLP [153, 162-163] as classical methods, and chance-constraint method as robust optimization [164-165]) can be used for energy management in MG. As meta-heuristic methods, genetic algorithm (GA) [34-36], particle swarm optimization (PSO) [166-168], and artificial bee optimization [169] were also found in the literature.

While scenario-based stochastic optimization algorithms were proposed in [170-172], the accuracy of the forecasted data in real-time depends on the training scenarios. That's why the desired functionality in MG energy management may not be performed correctly in the midst of real-time changes. The uncertainties of RESs, load demand, and electricity price were handled based on training scenarios via the Monte Carlo method in [170]. Piecewise linear function (PLF) based ADP was used to minimize the total operation cost of MG. Day-ahead and intra-day optimization were used by adding forecast error distribution to the forecast information.

Many studies propose online algorithm in real-time by taking into consideration uncertainties such as stochastic MPC [173-175] and Lyapunov optimization [171,176].

Rahbar [177] proposed a new online algorithm for real-time energy management based on sliding-window sequential optimization combining offline solution, assuming that the net energy profile is perfectly predicted or known ahead of time. In this study, however, optimal control in real-time completely depends on the offline solution which gives the prior information about net-energy profile. Moreover, the constraints of the load and battery were taken into account to minimize the energy cost. Su [178] and Kanvhev [179] studied double stage stochastic programming for energy management to minimize the operational cost. In the first stage, the authors performed day-ahead operational planning by using DP to minimize the economic cost and CO₂ equivalent emissions. In the second stage, an adjustment was carried to retrieve day-ahead plan by using a sequential quadratic programming method if the forecasted values change [179].

Another algorithm used in the literature is adaptive critic design (ACD) based algorithms, implemented to reduce the computational complexity in comparison with DP. Han [180] proposed a stochastic dynamic optimal control based on dual heuristic dynamic programming, which is a kind of adaptive-critic design method. The aim was to smoothen the PV and wind power output, reduce the system losses, and minimize the voltage deviation, without considering the cost of energy. The network model was not included in the optimization model. Venayagamoorthy [181] proposed model-free heuristic dynamic programming by updating the optimal control policy. To speed up the convergence, an evolutionary learning algorithm was used. However, the convergence totally depends on offline action-dependent heuristic dynamic programming (ADHDP) learning. In [182], the authors proposed ADHDP for residential MG. The system consists of PV and battery. ADHDP was used to reduce the electrical cost. Weather types and battery states are classified into categories 3 and 4, respectively. In this way, the computational complexity was reduced. The paper provided no exact information about how they handled uncertainty of solar power, load demand and electricity price in real-time. The main limitation of the adaptive critic design (ACD) based algorithm in real time is the computational power and communication delay.

One of the applications of tackling such challenges as nonlinearities, computational burden, and randomness in real-time is approximate dynamic programming, which is a powerful stochastic optimization modeling method. Liu [159] solved the optimization problem for residential MG which composes of wind turbine, solar panel, and shiftable/non-shiftable loads. To reduce the energy cost, the dynamic programming, Q-learning, and Lyapunov methods were used under perfect, partial and no information,

respectively. Then, centralized and distributed Q-learning and the Lyapunov methods were compared. Still, the main issue in this paper is that it did not consider a battery and only considered loads constraints, without extra constraints to model the microgrid. When perfect and partial knowledge about demand, electricity price, and the renewable energy profiles are known, in the no information scenarios, only real-time information is known. Das [183] proposed a post-decision value function approximation to minimize the daily operational cost of a diesel generator and battery for islanded MG energy management. They used uniform and pseudo normal distribution to find next wind power interval and load demand. However, the constraints of the network were not integrated to the optimization algorithm. Multi-time stochastic MINLP optimization was divided to single time stochastic nonlinear programming in [184]. This paper handled the uncertainty in similar fashion as the previous papers. They used day ahead and intra-day optimization by adding a forecast error distribution to the forecasted information. They used approximate dynamic programming (ADP) to reduce the operational cost. In [185], an ADP approach based on value function approximation with deep recurrent neural network was proposed to minimize the expected operational cost.

The EMSs presented in this thesis essentially use three different optimization algorithms: MINLP, MILP approach based on rolling horizon control, and reinforcement learning. Detailed information about these methods is given in the sections below.

3.2 Mixed integer nonlinear programming

Mixed integer nonlinear programming (MINLP) refers to numerical optimization problems with nonlinear functions in the objective function and/or the constraints as well as continuous and integer/binary variables. The canonical form of a MINLP is shown in equation (3.1):

$$\left. \begin{aligned} z_{MINLP} = & \text{minimize } f(x,y) \\ \text{subject to } & g(x,y) \leq 0, \\ & x \in X, y \in Y \cap \mathbb{Z}^p \end{aligned} \right\} \quad (3.1)$$

where $f: \mathbb{R}^{n \times p} \rightarrow \mathbb{R}$ and $g: \mathbb{R}^{n \times p} \rightarrow \mathbb{R}^m$ are twice continuously differentiable functions, x and y are continuous and discrete variables, respectively; X is polyhedral subset of \mathbb{R}^n , and Y is a bounded polyhedral subset of \mathbb{Z}^p .

Since the battery contains both binary variables, charging or discharging states, and nonlinear variable, and the calculation average cycle number at particular depth of discharge (DoD), MINLP is used in this thesis.

3.3 Rolling Horizon Control

Rolling horizon control (RHC) is an iterative and finite-time optimization approach that can be used for real-time/online issues. RHC aims to find the optimal solution for the current time step over sliding window by considering future time steps. RHC can compute the decision variables to fulfil the objective function, while considering exogenous information, future predictions, and constraints. In this way, RHC can adapt to new situation when a disturbance or fault occurs by changing the decision variables according to this new situation [186]. This algorithm considers different time horizons as shown Figure 3.1.

- The prediction horizon indicates how far in the future the model should predict the states of the system.
- The control horizon is the number of decisions to be optimized which should be applied to the system.

The operation logic of RHC is given in Figure 3.1. The model is simulated from the current time to prediction horizon (H steps forward in time) to obtain the predicted future values of the states. Then, these predicted values are used to create an optimization problem at each time step. After, the optimization problem is solved by optimization solvers to find best decision variables at the control horizon. In RHC, only the first decision variable is taken in the environment, then shifted to the next time step. The procedure continues recursively until the final scheduled period of time [187].

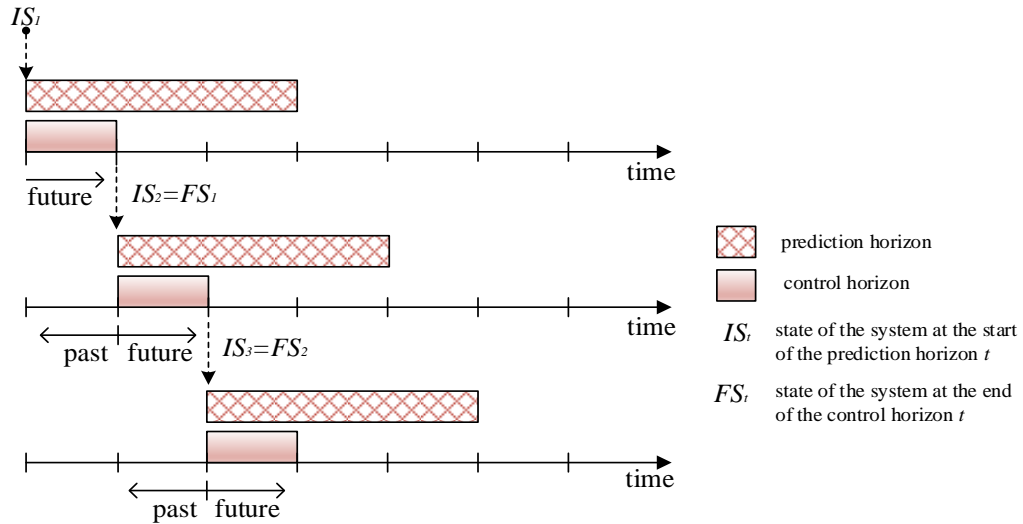

Figure 3.1 Rolling horizon framework [187]

3.4 Reinforcement learning

Reinforcement learning (RL) is one of the machine learning algorithms and differs in several aspects from other machine learning algorithms, classified as supervised learning and unsupervised learning. RL does not need a labelled dataset. The labelled dataset contains the answer or solution key, so the model is trained with the solution key to find correct answer. RL does not discovers patterns that exist in the dataset. In RL, the agent learns by directly interacting with its environment through trial-and-error without any supervisor. The following discussion is based on Sutton and Barto [188].

In essence, RL uses a framework that consists of agent, environment, state, action, and reward, as shown in Figure 3.2. The agent is defined as learner or decision maker. The environment is where the agent interacts and performs actions at each time step t . At each time step t , the agent obtains an observation, $S_t \in \mathcal{S}$, from its environment. Then, it takes an action, $A_t \in \mathcal{A}(s)$, according to the observation following the behavior policy. The environment is affected by the action taken, the agent receives a reward value, $R_{t+1} \in \mathcal{R} \subset \mathbb{R}$, to evaluate the action and finds itself in a new state S_{t+1} . So, this process gives us a sequence like $S_0, A_0, R_1, S_1, A_1, R_2, S_2, A_2, R_3 \dots$. In that way, the agent's goal is to maximize the total amount of reward obtained from the environment by learning an optimal action strategy.

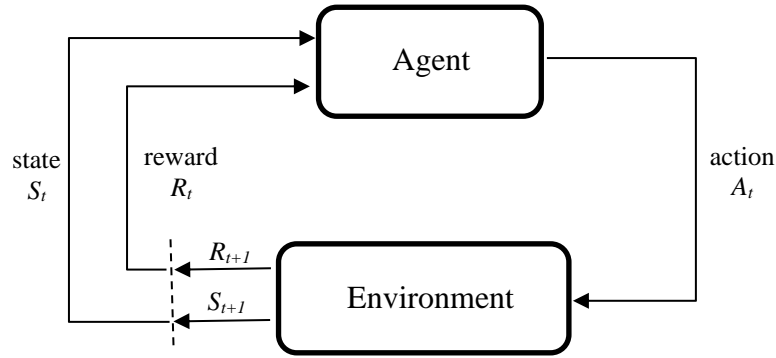

Figure 3.2 Agent and environment interactions in reinforcement learning

Beyond the agent, the environment and the reward, there are three main sub-elements in RL:

- **Policy:** Policy maps the action based on the agent’s state. That is, it tells us which action to take in state s , and can be deterministic or stochastic:
 - Deterministic: $\pi(s) = a$
 - Stochastic: $\pi(a|s) = \Pr(a_t = a | s_t = s)$
- **Value function:** Value function estimates the “how good” it is to be in a given state in the long term. While the reward demonstrates what is good and what is bad at each time step (immediate reward), value function shows the total amount of reward an agent has collected over the long run, which is called as return, G_t :

$$G_t = R_{t+1} + \gamma R_{t+2} + \gamma^2 R_{t+3} + \dots = \sum_{k=0}^{\infty} \gamma^k R_{t+k+1} \quad (3.2)$$

where γ is called as discount rate, $0 \leq \gamma \leq 1$. The discount rate is used to reduce the future rewards’ effect on the action choice.

The state value function, $v_{\pi}(s)$, returns the expected return when starting in a certain state s and following then policy π :

$$v_{\pi}(s) = \mathbb{E}_{\pi}[G_t | S_t = s] = \mathbb{E}_{\pi} \left[\sum_{k=0}^{\infty} \gamma^k R_{t+k+1} | S_t = s \right] \quad (3.3)$$

for all $s \in S$. $\mathbb{E}_{\pi}[\cdot]$ denotes the expected value by following policy π , and t is any time step.

Similarly, the action value function under policy π , $q_{\pi}(s, a)$, is the expected return for taking the action a in a certain state s :

$$q_\pi(s, a) = \mathbb{E}_\pi[G_t | S_t = s, A_t = a] = \mathbb{E}_\pi[\sum_{k=0}^{\infty} \gamma^k R_{t+k+1} | S_t = s, A_t = a] \quad (3.4)$$

- **Model:** It helps the agent to observe the behavior of the environment. So, the model can infer how the environment will behave for given state and action by knowing probability distributions. In other words, there is a probability distribution, p , of each choice of state s to move next state s' after taking action a while obtaining reward R :

$$p(s', r | s, a) = Pr\{S_t = s', R_t = r | S_{t-1} = s, A_{t-1} = a\} \quad (3.5)$$

for all $s', s \in \mathcal{S}, r \in \mathcal{R}$, and $a \in \mathcal{A}(s)$.

So, the state-transition probabilities can be defined as a function of $p(s', r | s, a)$:

$$p(s' | s, a) = Pr\{S_t = s' | S_{t-1} = s, A_{t-1} = a\} = \sum_{r \in \mathcal{R}} p(s', r | s, a) \quad (3.6)$$

Expected rewards for state-action pairs can also be computed as:

$$r(s, a) = \mathbb{E}[R_t | S_{t-1} = s, A_{t-1} = a] = \sum_{r \in \mathcal{R}} r \sum_{s' \in \mathcal{S}} p(s', r | s, a) \quad (3.7)$$

3.3.1 Optimal value function and optimal policy

An optimal state value or an action value achieves the maximum expected return. the optimal state value function and the optimal action value function are defined respectively as:

$$v_*(s) = \max_{\pi} v_\pi(s), \text{ for all } s \in \mathcal{S} \quad (3.8)$$

$$q_*(s, a) = \max_{\pi} q_\pi(s, a), \text{ for all } s \in \mathcal{S} \text{ and } a \in \mathcal{A}(s) \quad (3.9)$$

q_* can be written in terms of v_* as follows:

$$q_*(s, a) = \mathbb{E}[R_{t+1} + v_*(S_{t+1}) | S_t = s, A_t = a] \quad (3.10)$$

A policy that produces the optimal state value or action value is called the optimal policy. The optimal policy can be defined as follows:

$$\pi_*(s) = \arg \max_{\pi} v_\pi(s) \quad (3.11)$$

$$\pi_*(s) = \arg \max_{\pi} q_\pi(s, a) \quad (3.12)$$

So, we can write the following equation for an optimal policy:

$$v_*(s) = \max_{a \in \mathcal{A}(s)} q_{\pi^*}(s, a) \quad (3.13)$$

3.3.2 Markov decision process (MDP)

RL is modelled as an MDP, which is a mathematical framework of sequential decision making. MDPs mean that the next state and reward depend only on the current state and action because the current observation summarizes all previous experiences. This can be formulated as:

$$Pr(S_{t+1}, R_{t+1} | S_0, A_0, R_1, \dots, S_{t-1}, A_{t-1}, R_t, S_t, A_t) = Pr(S_{t+1}, R_{t+1} | S_t, A_t) \quad (3.14)$$

A MDP consists of five elements as listed below (which were defined in the previous section):

- S - a set of states;
- A - a set of actions;
- p - state- transition probability function;
- R - reward function;
- γ - discount rate.

3.3.3 Bellman Equations

Bellman equations helps us to solve MDP. Therefore, they form the basis of solving RL problems. Bellman Equations decompose the value functions into two parts: immediate reward and discounted future value function.

State value function for a policy π can be broken into:

$$\begin{aligned} v_\pi(s) &= \mathbb{E}_\pi[G_t | S_t = s] \\ &= \mathbb{E}_\pi[R_{t+1} + \gamma G_{t+1} | S_t = s] \\ &= \sum_a \pi(a|s) \sum_{s'} \sum_r p(s', r | s, a) [r + \gamma \mathbb{E}_\pi[G_{t+1} | S_{t+1} = s']] \\ &= \sum_a \pi(a|s) \sum_{s'} \sum_r p(s', r | s, a) [r + \gamma v_\pi(s')] \quad \text{for all } s \in S \end{aligned} \quad (3.15)$$

Action value function for a policy π can be broken into:

$$\begin{aligned} q_\pi(s, a) &= \mathbb{E}_\pi[G_t | S_t = s, A_t = a] \\ &= \mathbb{E}_\pi[R_{t+1} + \gamma G_{t+1} | S_t = s, A_t = a] \\ &= \sum_{s'} \sum_r p(s', r | s, a) [r + \gamma \mathbb{E}_\pi[G_{t+1} | S_{t+1} = s', A_{t+1} = a']] \\ &= \sum_{s'} \sum_r p(s', r | s, a) [r + \gamma q_\pi(s', a')] \end{aligned} \quad (3.16)$$

Expanding equation (3.4) with equation (3.13), Bellman optimality equations for state-value function are obtained as follows:

$$\begin{aligned}
v_*(s) &= \max_{a \in \mathcal{A}(s)} q_{\pi^*}(s, a) \\
&= \max_a \mathbb{E}_{\pi^*}[G_t | S_t = s, A_t = a] \\
&= \max_a \mathbb{E}[R_{t+1} + \gamma v_*(S_{t+1}) | S_t = s, A_t = a] \\
&= \max_a \sum_{s', r} p(s', r | s, a) [r + \gamma v_*(s')]
\end{aligned} \tag{3.17}$$

Bellman optimality equations for action-value function:

$$\begin{aligned}
q_*(s, a) &= \mathbb{E} \left[R_{t+1} + \gamma \max_{a'} q_*(S_{t+1}, a') | S_t = s, A_t = a \right] \\
&= \sum_{s', r} p(s', r | s, a) \left[r + \max_{a'} q_*(s', a') \right]
\end{aligned} \tag{3.18}$$

For the cases in which the transition probabilities and reward functions are known (model-based), Bellman optimality equations can be solved via dynamic programming. As the transition probabilities and reward function are not available, model free algorithms are used (such as Monte Carlo, temporal difference (TD), and policy search methods). This thesis implements Q -learning, which is an off-policy TD control algorithm.

3.3.4 Q -learning

Q -learning is an efficient algorithm of RL to solve the MDP based optimization problem without an explicit environment model. The objective of the Q -learning is to seek the optimal policy by maximizing the expected discounted reward of actions based on the given states. The output of the Q -table for a state S and an action A is represented as $Q(S, A)$. In Q -learning, the Q -values of each action A when performed in a state S can be updated recursively using Bellman's action-value function as follows:

$$Q(S_t, A_t) \leftarrow Q(S_t, A_t) + \alpha \left[R_{t+\Delta t} + \gamma \max_a Q(S_{t+\Delta t}, a) - Q(S_t, A_t) \right] \tag{3.19}$$

where $\gamma \in [0, 1]$ is a discount parameter, learning parameter $\alpha \in [0, 1]$ decreases over time interval Δt in the suitable way. $R_{t+\Delta t}$ is the immediate reward when the agent takes action A at state S . (S_t, A_t) is the state-action pair and $(S_{t+\Delta t}, a)$ is the possible state-action pair in the next time interval. The immediate reward is defined as the daily cost of the MG system.

The basic principle behind Q -learning is that the agent takes an action based on the ε -greedy policy, which is a way to choose an action from a set of feasible action. The agent selects the best action with probability $(1-\varepsilon)$ or takes actions randomly with probability ε to discover new actions. The taken action gives rise to a change of the environmental state, so the agent transitions to a new state and observes the immediate reward from taking action A in state S . Then, the Q -value for a given state S and action A is updated. The Q -learning algorithm is shown in Algorithm 1. The optimal value of a state at each iteration is obtained by computing the maximum value.

$$Q_*(S_t, a_t) \doteq \max_{a \in \mathcal{A}} Q(S_t, a_t) \quad (3.20)$$

Algorithm 1: Q-learning

Initialize $Q(s, a), \forall s \in \mathcal{S}, a \in \mathcal{A}(s)$, arbitrarily, and $Q(\text{terminal}, \cdot) = 0$

Repeat (for each episode):

 Initialize S

 Repeat (for each step of episode):

 Choose A from S using policy derived from Q (e.g., ε -greedy)

 Take action A , observe R, S'

$$Q(S, A) \leftarrow Q(S, A) + \alpha \left[R + \gamma \max_a Q(S', a) - Q(S, A) \right]$$

$S \leftarrow S'$

 until S is terminal

In conventional Q -learning, the Q values are stored in a lookup table. This approach is especially suitable for a small number of state-action spaces. As the state-action space increases, it will become impossible to store all Q values in a lookup table because an enormous storage capacity is required to store the data. This phenomenon is known as the “curse of dimensionality.” Moreover, this approach is computationally expensive because the time required to visit all the states becomes impossible. The proposed method to enhance of the performance of original Q -learning algorithm is given in Chapter 5.

Chapter 4

Dynamic Rolling Horizon Control Approach

An energy management system based on the rolling horizon control approach has been proposed for the grid-connected dynamic and stochastic microgrid of a university campus in Malta. The aims of the study are to minimize the fuel cost of the diesel generator, minimize the cost of power transfer between the main grid and the micro grid, and minimize the cost of deterioration of the battery to be able to provide optimum economic operation. Since uncertainty in renewable energy sources and load is inevitable, rolling horizon control in the stochastic framework is used to manage uncertainties in the energy management system problem. Both the deterministic and stochastic processes were studied to identify the effectiveness of the algorithm. In addition, the results are compared with the myopic and mixed integer linear programming algorithms. The results reveal that the life span of the battery and the associated economic savings are correlated with the SOC values.

4.1 Introduction

Optimization methods are used to find the best solutions for controlling the MG by ensuring stable and reliable operation. Existing studies in the literature are classified as deterministic MG operation or stochastic MG operation [189-191]. In the deterministic operation, RES power output and load demand have not been taken into consideration as a measure of uncertainty. Only accurately forecasted variables are considered to achieve the desired objectives. Since unexpected power changes in real time operation, which affect the economic dispatch or ancillary services, cannot be effectively addressed in the

deterministic model, the optimal operation of MG cannot be performed properly [146,148].

Stochastic based energy management of MG has also been studied to tackle the uncertainty problem of RESs and loads. Several approaches exist, which are generally based on scenario-based stochastic optimization algorithm [192-194]. Since these scenarios or samples are generated from historical data, the accuracy of the forecasted data in real-time depends on the training scenarios. Therefore, the desired functionality in microgrid energy management may not be performed correctly in the face of real-time changes. This is because a high number of scenarios causes computation complexity, which is unacceptable in most real-world applications. For this reason, scenarios reduction approaches are needed to eliminate the scenarios without loss of critical information [195-196].

The rolling horizon control (RHC), also known as model predictive control (MPC), is used in the literature to solve different control issues in microgrids. RHC can cope with the randomness and intermittence nature of RESs and load demand in real-time microgrid operation. In [197], scenario-based rolling horizon is proposed via a two stage stochastic formulation to minimize the operational cost, including the costs of generators and batteries, purchases, penalties, and revenues from electricity exported to the grid. The other paper used a scenario-based model predictive control to minimize the operating cost and total emission of toxic gases [198]. Two stage stochastic approach is formulated as mixed integer linear programming problem (MILP), incorporating model predictive control, and considering load and renewable energy generation uncertainties. The work in [173] proposes a chance constraint MPC for a grid-connected microgrid composed of a gas turbine, battery, and PVs. The authors aimed to minimize the deviation with optimal schedule by taking into consideration uncertainty in the low-level control unit, while high level is used to make economic optimization over a long-time horizon. A four-level MPC controller was proposed with different electricity market rules in [199]. Also, different kinds of ESS were included in the system to achieve system objectives without considering losses and power flows limits. The study in [200] proposes a fitted rolling horizon control for the stochastic situations, in case of mission or no forecast information. These studies are limited in scope because there is no consideration of battery degradation, and the network constraints are missing.

This paper suggests a real-time energy management system with RHC for a MG operation under a stochastic and dynamic environment by taking network constraints and

battery degradation into account. Stochastic RHC is used to plan the MG operation over 24 hours, and with a time interval with 1h. The aim of the study is to minimize the operational cost, including the battery degradation cost, the energy cost of main grid, and the fuel cost of the diesel generator. The suggested algorithm has been tested in a real MG pilot of the Malta College of Arts, Science and Technology (MCAST) by considering the constraints of the network model. Formulation of the MG system, including all constraints and limitations, has nonlinear equations, with the nonlinearity issue handled through an adaptive grid search algorithm. Through this, the optimum value has been obtained in a very short time. The proposed model is formulated as mixed integer linear programming (MILP), which is solved by the CPLEX solver included in GAMS.

4.2 Microgrid Model Description

The scheme of the microgrid system is shown in Figure 4.1 below. The system is comprised of solar PV arrays (63 kW in total), a diesel generator (300 kW), lithium-ion batteries (300 kWh capacity in total), and loads. This paper assumes that the microgrid operates in grid-connected mode. A finite time horizon of the microgrid operation is considered as $\tau = \{0, \Delta t, 2\Delta t, \dots, T - \Delta t, T\}$, where $\Delta t = 1$ hour is the time interval and $T = 24$ hours.

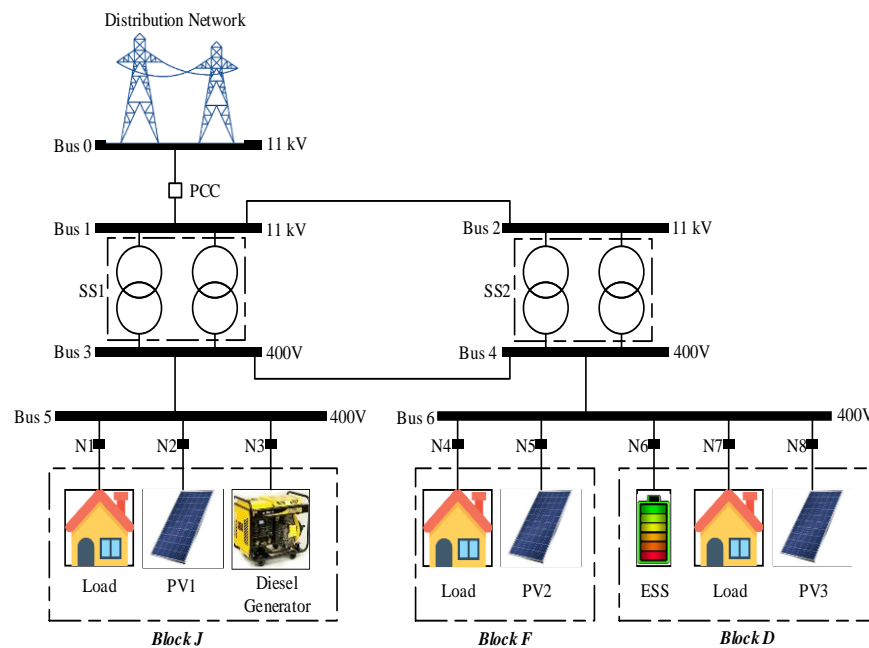

Figure 4.1 Schematic diagram of microgrid

4.2.1 Battery Model

The energy storage system is one of the core parts of the microgrid system, which can improve the microgrid system performance. Because the initial investment cost of a battery is high, it is crucial to extend the battery life. The battery cycle life is directly related to the depth of discharge (DoD). The cycle life data is given by the battery manufacturer in the form of total cycle number with respect to the DoD. The relationship between the expected cycle life and DoD is exponential for the li-ion battery, as given in (4.1).

$$L(D) = D^a e^b \quad (4.1)$$

where D is the DoD in percentage at which the battery is cycled, L denotes the average cycle number at that particular D , and a and b are battery dependent coefficients. From the logarithmic fitted curve between DoD and cycle life specified in the data sheet of the battery used, these coefficients are found as $a = -1.24$, $b = 7.043$. From the fitted curve, battery wear cost in € per kWh can be calculated as follows:

$$C_W = \frac{C_{inv}}{2E_{max}L(D)D\eta^d\eta^c} \quad (4.2)$$

where C_{inv} is the capital cost of battery; E_{max} is the total capacity of battery; and η^c and η^d are the charging and discharging efficiencies, respectively.

The operation cost of a battery based on wear cost is written as:

$$C_{bat} = C_W P_{bat,t} \Delta t \quad (4.3)$$

where $P_{bat,t}$ is the charging or discharging power of the battery at time t .

At any given time, the state of charge (SOC) of the lithium- ion battery system should be within a certain range. It can be expressed as:

$$SOC_{min} \leq SOC_t \leq SOC_{max} \quad (4.4)$$

where SOC_{min} and SOC_{max} are the lower limit and upper limit of SOC, respectively. The charging and discharging states, charging and discharging power limits, and SOC formulation of the lithium-ion battery are given respectively as follows:

$$u_{bat,t}^c + u_{bat,t}^d \leq 1 \quad (4.5)$$

$$u_{bat,t}^c, u_{bat,t}^d \in \{0,1\}$$

$$0 \leq P_{bat,t}^d \leq u_{bat,t}^d P_{max}^d \quad (4.6)$$

$$0 \leq P_{bat,t}^c \leq u_{bat,t}^c P_{max}^c \quad (4.7)$$

$$SOC_t = \begin{cases} SOC_{t-\Delta t} - \frac{P_{bat,t}^d \Delta t}{\eta^d \cdot E_{max}} & P_{bat,t}^d > 0 \\ SOC_{t-\Delta t} + \frac{\eta^c P_{bat,t}^c \Delta t}{E_{max}} & P_{bat,t}^c > 0 \end{cases} \quad (4.8)$$

where $u_{bat,t}^c$ and $u_{bat,t}^d$ are the charging and discharging states of the battery, respectively; $P_{bat,t}^c$ and $P_{bat,t}^d$ are the charging and discharging power of the battery, respectively; and P_{max}^c and P_{max}^d are the maximum charging and discharging power of the battery, respectively. The charging efficiency (η^c) and discharging efficiency (η^d) are both assumed to be 95%, according to the practical situation of the MCAST system.

4.2.2 Diesel Generator (DG)

The hourly fuel consumption FC_t of a DG is modeled as a linear function, which is based on data provided by the manufacturer.

$$FC_t = F_1 P_{rated} + F_2 P_{dg,t} \quad (4.9)$$

where F_1 and F_2 are the coefficients of fuel consumption function, which are set as 0.0183 and 0.22, respectively; and P_{rated} and $P_{dg,t}$ are the rated power and the actual output power of DG, respectively.

The power limits of DG are imposed as:

$$kP_{rated} \leq P_{dg,t} \leq P_{rated} \quad (4.10)$$

where k is set to be 0.3 based on the suggestion of manufacturers.

The fuel cost of DG at time step t can be calculated as:

$$C_{dg,t} = C_{fuel} FC_t \Delta t \quad (4.11)$$

where C_{fuel} is the fuel cost.

4.2.3 Main grid

The power transaction between main grid and microgrid should be constrained as:

$$-P_{grid}^{max} \leq P_{grid,t} \leq P_{grid}^{max} \quad (4.12)$$

where $P_{grid,t}$ is the active power exchange between microgrid and main grid at time t ; and P_{grid}^{max} is the maximum active power that can be exported to and imported from the main grid.

The cost related to the power transaction at time step t is:

$$C_{grid,t} = prc_t P_{grid,t} \Delta t \quad (4.13)$$

where prc_t is the real-time electricity price at time step t .

4.2.4 AC Power Flow

The power flow limits in each branch ij are considered as:

$$P_{ij,t} = \frac{|V_{i,t}^2| \cos(\theta_{ij})}{|Z_{ij}|} - \frac{|V_{i,t}| |V_{j,t}| \cos(\delta_{i,t} - \delta_{j,t} + \theta_{ij})}{|Z_{ij}|} \quad (4.14)$$

$$Q_{ij,t} = \frac{|V_{i,t}^2| \sin(\theta_{ij})}{|Z_{ij}|} - \frac{|V_{i,t}| |V_{j,t}| \sin(\delta_{i,t} - \delta_{j,t} + \theta_{ij})}{|Z_{ij}|} \quad (4.15)$$

$$P_{ij,t}^2 + Q_{ij,t}^2 \leq (S_{ij}^{max})^2 \quad (4.16)$$

where the subscript $i, j \in \{1, 2, \dots, n\}$ are the indexes of the MG system bus and n is the total number of the bus; $P_{ij,t}$ and $Q_{ij,t}$ are the active and reactive power flows of branch ij , respectively; $|V_{i,t}|$ and $\delta_{i,t}$ are the voltage amplitude and angle at bus i , respectively; $|Z_{ij}|$ and θ_{ij} are the impedance magnitude and corresponding phase angle of branch ij , respectively; and S_{ij}^{max} is the maximum complex power flow of branch ij .

The transmission capacity limit of power cables is also considered as:

$$P_{ij,t} \leq P_{ij}^{max} \quad (4.17)$$

where P_{ij}^{max} is the maximum power flow limit from bus i to bus j .

The voltage amplitude limit is bounded by:

$$V_i^{min} \leq |V_{i,t}| \leq V_i^{max} \quad (4.18)$$

where V_i^{min} and V_i^{max} are the minimum and maximum voltage magnitudes of bus i , respectively.

The power balance equation is also considered as:

$$P_{pv,t} + P_{grid,t} + P_{dg,t} + (P_{bat,t}^d - P_{bat,t}^c) = P_{ij,t} + P_{L,t} \quad (4.19)$$

where $P_{pv,t}$ is the total active power output of PV arrays; and $P_{L,t}$ is the total active load demand.

4.2.5 Objective Function

The objective function of this study is to minimize the daily operational cost, which includes the degradation cost of battery, the fuel cost of the diesel generator and the cost

of power transaction between the main grid and microgrid. Thus, the objective function can be expressed as:

$$C_t(S_t, a_t) = C_{bat,t}(S_t, a_t) + C_{dg,t}(S_t, a_t) + C_{grid,t}(S_t, a_t) \quad (4.24)$$

Exogenous information vector E_t , includes at time t , which is given by:

$$\hat{E}_t = \{\hat{P}_{L,t}, \hat{P}_{pv1,t}, \hat{P}_{pv2,t}, \hat{P}_{pv3,t}\} \quad (4.25)$$

where $\hat{P}_{L,t}, \hat{P}_{pv1,t}, \hat{P}_{pv2,t}, \hat{P}_{pv3,t}$ are the available information in the load demand and PV power of each building at time t , respectively.

The exogenous information includes random forecast error (ε), so the exogenous information at time $t+\Delta t$ is given by:

$$E_{t+\Delta t} = \hat{E}_{t+\Delta t} + \varepsilon \quad (4.26)$$

The available information at time t can be expressed as:

$$I_t = (SOC_t, E_t, E_{t+1}, \dots, E_{t+H}) \quad (4.27)$$

where E_t is the available exogenous information at time t , $E_{t+1:t+H}$ is the future exogenous information with random forecast error between time $t+1$ to $t+H$.

The decision variables vector a_t of the problem can be given as by:

$$a_t = \{P_{bat,t}^d, P_{bat,t}^c, P_{dg,t}, P_{grid,t}, P_{pv1,t}, P_{pv2,t}, P_{pv3,t}\} \quad (4.28)$$

where $P_{bat,t}^d, P_{bat,t}^c$ are the discharge and charge power, respectively. $P_{dg,t}, P_{grid,t}$ represent the dispatched power of the DG and transferred power between the main grid and microgrid, respectively. $P_{pv1,t}, P_{pv2,t}, P_{pv3,t}$ represent the injected power by solar panels.

The overall operational cost can be minimized as:

$$V = \min E \left[\sum_{t=1}^T C(t, I_t) \right] \quad (4.29)$$

4.3 Rolling Horizon Control Approach

The operation flowchart of the MILP based rolling horizon control is given in Figure 4.2 below. The algorithm is initialized by setting horizon size H , time period T , and the initial SOC value of the battery. Then, the exogenous data (PV power and demand) are updated for prediction horizon H . These exogenous data and current state of

the system (which is called available information for $t:t+H$) are sent to the optimizer (the CPLEX solver of GAMS). After the MILP optimization problem is solved from t to $t+H$ at time t subject to constraints, optimal decision variables are obtained. While only the first decision variable is applied to the MG system, the operational cost is calculated and the SOC value is observed for the following time step. Then, it is moved to the next time step. This process continues for each time step of one hour until the optimization horizon T is reached. This means that an optimization problem is solved at each time step with an updated information set.

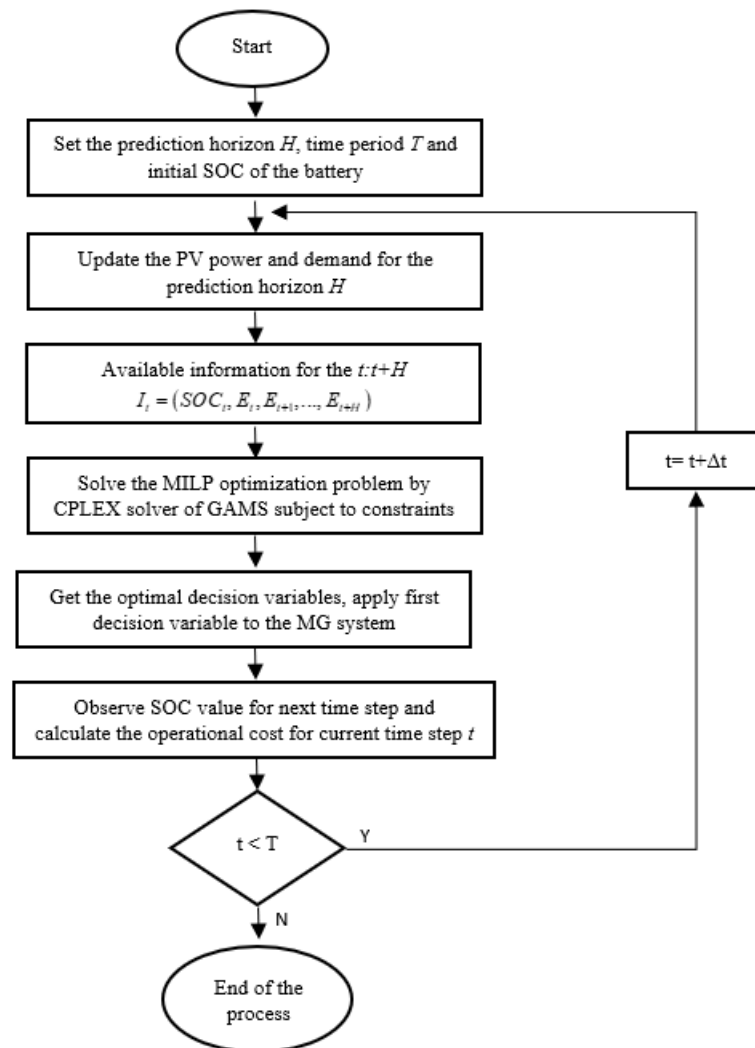

Figure 4.2 The flowchart of energy management process

To cope with the nonlinearity property of the power flow equation, adaptive grid search is used to find the minimum and maximum values of power flow between buses

by taking into consideration voltage and phase angle limits. In this way, there will not be voltage and phase angle violations. Thus, the computation time is drastically reduced.

4.4 Simulation Environment & Numerical Analysis

4.4.1 Simulation Environment

The MG is equipped with a 300 kW/375 kVA DG, 3x21 kW solar generators, and 150 kW/300 kWh battery as shown in Figure 4.1 above. The distribution line parameters are presented in Table 4.1 below, while the parameters of DG and the battery are given Table 4.2 and Table 4.3, respectively.

Table 4.1 Parameters of distribution lines

Line		Resistance	Reactance
From	To	(mΩ)	(mΩ)
Bus 0	Bus 1	129	78.225
Bus 1	Bus 2	19.737	11.969
Bus 3	Bus 4	11.536	12.208
Bus 3	Bus 5	3.770	3.989
Bus 4	Bus 6	3.770	3.989
Bus 5	N1	3.770	3.989
Bus 5	N2	3.770	3.989
Bus 5	N3	3.770	3.989
Bus 6	N4	9.048	9.550
Bus 6	N5	9.048	9.550
Bus 6	N6	4.901	5.186
Bus 6	N7	6.786	7.181
Bus 6	N8	6.786	7.181

Table 4.2 Parameters of DG

Parameter	Value	Parameter	Value
P_{rated} (kW)	300	k	0.3
F_1 (L · h ⁻¹ · kW ⁻¹)	0.0183	C_{fuel} (€/L)	1.1
F_2 (L · h ⁻¹ · kW ⁻¹)	0.22		

Table 4.3 Parameters of lithium-ion battery

Parameter	Value	Parameter	Value
E_{max} (kWh)	300	P_{max}^d (kW)	50
Cycle life	2700 @50% DoD	P_{max}^c (kW)	40
η^d, η^c	0.95, 0.95	a	-1.24
SOC_{min} (%)	50	b	7.043
SOC_{max} (%)	100	Battery Cost (€/kWh)	220

The stochastic load demand and stochastic PV power supply can be modelled as:

$$P_{L,t+1} = \min\{\max\{P_{L,t} + \varepsilon_{t+1}^L, P_{L,min}\}, P_{L,max}\} \quad (4.30)$$

$$P_{pv,t+1} = \min\{\max\{P_{pv,t} + \varepsilon_{t+1}^{pv}, P_{pv,min}\}, P_{pv,max}\} \quad (4.31)$$

where ε^L and ε^{pv} is either pseudo normally or uniformly distributed. In this study, $\varepsilon^L \sim \mathcal{N}(0, 2^2)$ and $\varepsilon^{pv} \sim \mathcal{N}(0, 0.5^2)$. After the probabilities are calculated for load demand and PV power as in [201], the exogenous variables for the next time interval are calculated using equations (4.30) and (4.31). The stochastic load demand profile and PV power profile are shown in Figure 4.3. The electricity price is represented in Figure 4.4 below.

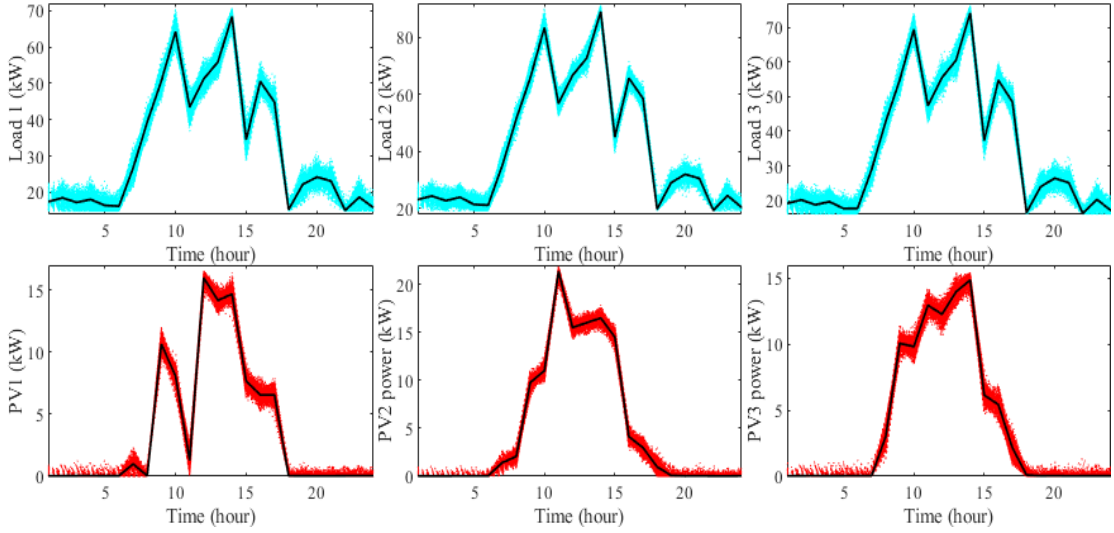

Figure 4.3 Load demand and PV power generation for each building in stochastic case

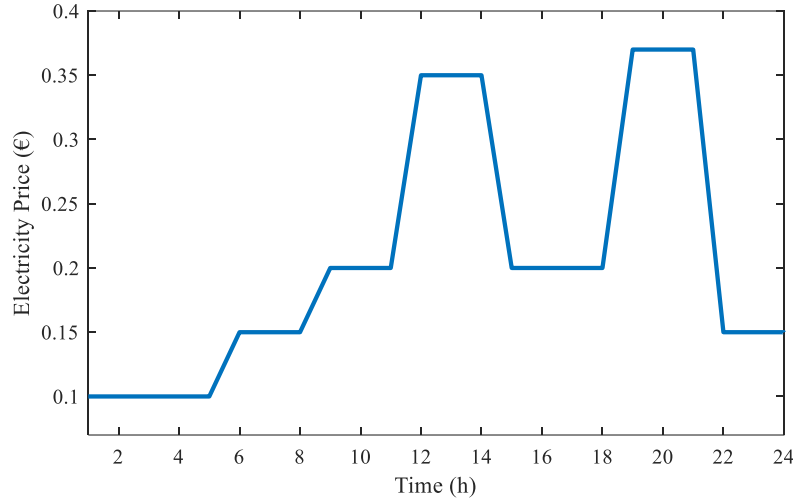

Figure 4.4 Profile of electricity price

The percentage of optimality (%) is found by the following equation:

$$\% \text{ percentage of optimality} = \frac{V^*}{V} \times 100\% \quad (4.32)$$

where V is the daily operational cost of the MG system using RHC and V^* is the reference (optimal) operational cost obtained from MILP.

4.4.2 Numerical Analysis

4.4.2.1 Deterministic Case

In this case, the deterministic dataset of PV power and load demand are used as input at each time step. To determine the horizon length of the RHC, the optimality percentage is calculated for each time horizon until obtaining the optimum operation cost of the microgrid. When the optimal percentage is obtained as 100% at horizon h , we can observe the optimal value of the system. As shown in Figure 4.5, when horizon size $h=0$, optimality is 97.84%. It is seen that as the horizon length increases, the optimality reaches 100%. In this study, 100% optimality obtained at $h=11$, so with values larger than 11, the optimal value can be achieved. For the examples in this section, the prediction horizon of 11 hours is used with known exogenous data. Since each hour has a total of seven decision variables, a total of 77 decision variables must be resolved over the prediction horizon. MILP is applied to obtain the decision variables (PV power outputs, charge and discharge power of the battery, dispatched power of the DG, and transferred power between the main grid and MG) which are used to achieve the minimum operation cost. Table 4.4

shows the comparison of the optimization approaches in terms of daily operational cost and percentage of optimality. While the myopic approach achieves 97.84% optimality, the optimality percentage using MILP based RHC is obtained as 100%. In this case, the traditional MILP is used to obtain a reference daily operational cost value.

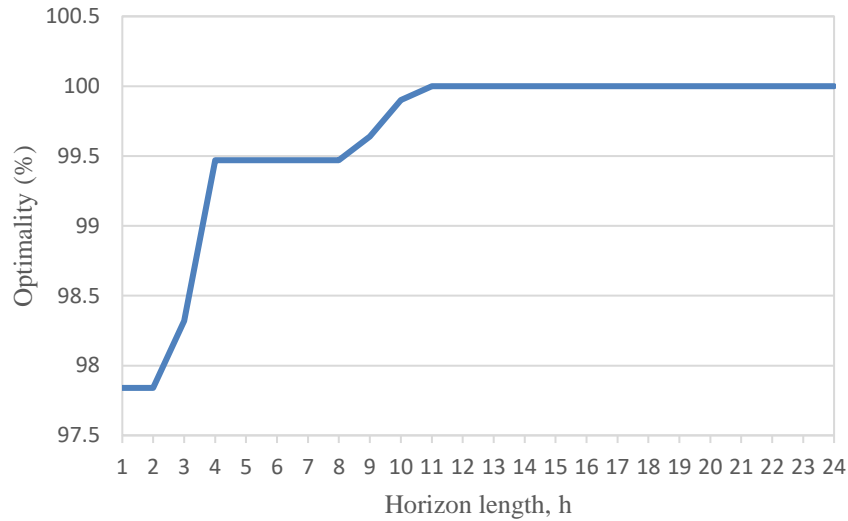

Figure 4.5 Percentage of the optimality

Table 4.4 Performance comparison for deterministic case

Approaches	Operational cost (€)	% of optimality
MILP	510.6646	-
RHC	510.6646	100 %
Myopic	521.9159	97.84 %

4.4.2.2 Stochastic Case

In this case, two different probability distribution functions, uniform (U) and normal (N) distributions, are used to make the system stochastic. For example, $U(-1,1)$ represents the uniform distributed numbers in the interval $(-1,1)$. For the one of the other cases, $N(0,2^2)$ shows the normal probability distribution, where the mean is 0 and the variance is 2. After obtaining the noise values, the PV power and load demand are calculated using equation (4.30) and (4.31).

Table 4.5 shows the comparison of the performance of the MILP based RHC and the percentage of the optimality according to different stochastic test problems. In this

case, 300 simulation runs were conducted, with the average daily costs reported in table below. All test problems were conducted when the SOC of the battery was at 75%. For example, for problem no. 1, the average daily operational cost of the microgrid system is obtained as €510.4034, where the optimal cost incurred by MILP is €510.3115. So, the percentage of optimality in this problem is estimated as 99.98%. The results show that optimality of at least 99.94% is achieved via stochastic RHC. Moreover, the average daily costs and percentage of optimality were calculated by myopic approach for comparison.

Table 4.5 Performance comparison for stochastic case with different noises

Problem No.	Noise	MILP-based RHC		Myopic approach	
		Average Daily Cost (€)	% of optimality	Average Daily Cost (€)	% of optimality
1	N(0,0.5 ²)	510.4034	99.98%	521.8671	97.78%
2	N(0,1.0 ²)	510.4307	99.97%	522.0690	97.74%
3	N(0,1.5 ²)	510.4849	99.96%	522.2638	97.71%
4	N(0,2.0 ²)	510.6103	99.94%	522.4578	97.67%
5	U(-1,1)	510.3233	99.99%	521.9851	97.76%

The power outputs of the battery, DG, PVs and main grid are presented in Figure 4.6. The results show that the battery stores energy when the main electricity price is lowest between 4-5 h. Then, PV power is dispatched as long as it is available. When the operational cost of DG is cheaper than the electricity price, DG is activated between 12-14h and 19-21h. Because DG is operated at 90 kW minimum, power can be bought/sold from/to the main grid in that situation. Table 4.6 shows the effect of the battery SOC on the average daily operational cost.

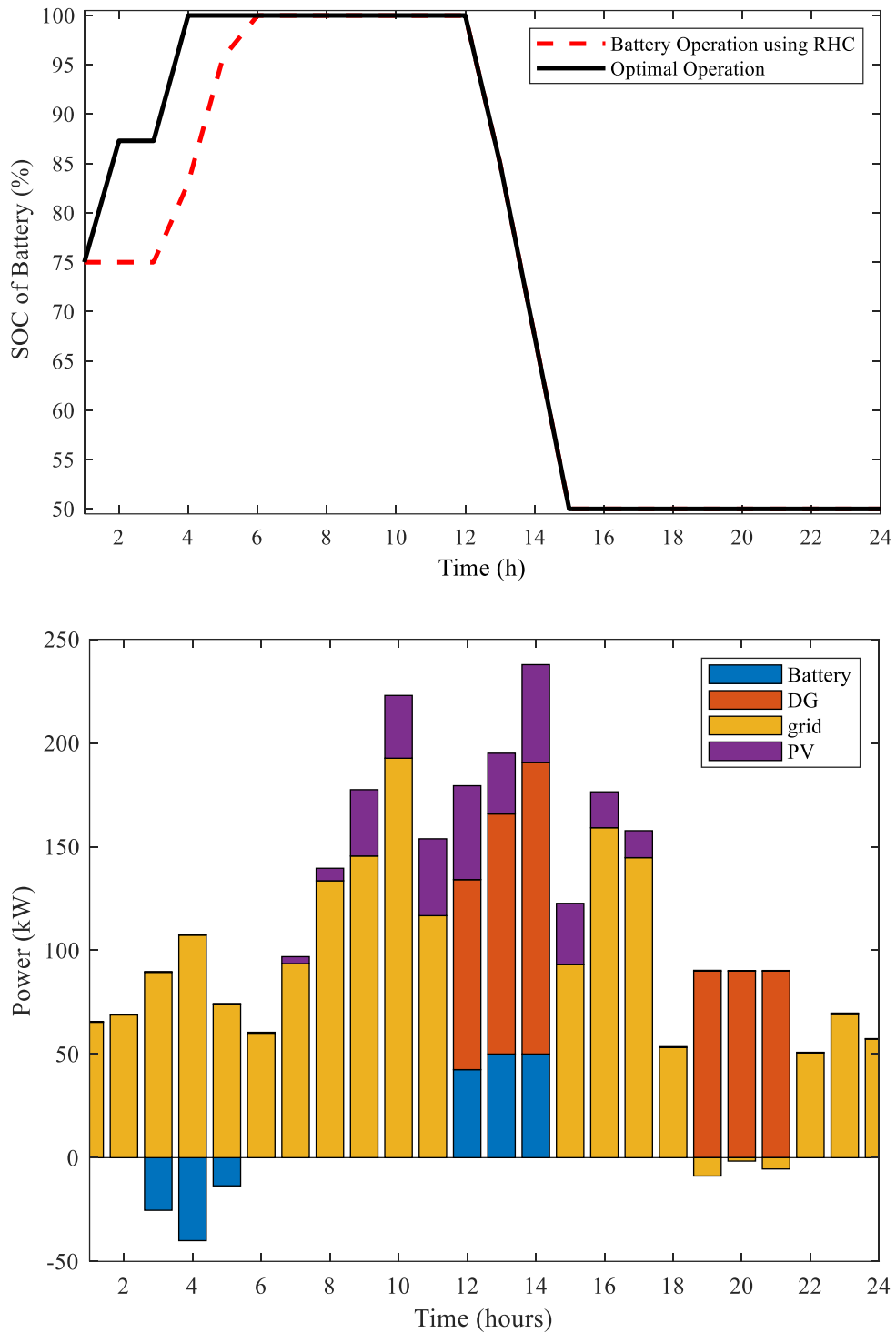

Figure 4.6 Behaviour of the SOC value and power outputs of the assets at each time step, respectively

Table 4.6 shows the effect of the DoD of the battery in terms of battery life and daily operational cost in the stochastic case. We assume that the average battery throughput during a year is as stated in Table 4.6. When the battery is operated at 55% DoD, the daily operational cost and battery throughput are €509.3745 and 144.1437kWh,

respectively. As the level of DoD drops, we can see from the table that the daily operational cost increases to €513.6191 at 40% DoD and battery throughput falls to 114.00 kWh. In terms of battery life extension, it is assumed that battery life is on average 10 years and the total capital cost of the battery is (300 kWh x 220 €/kWh) €66,000. So, the calculated cost for each year is €6,600. Thus, the battery life increases from 7.15 years to 9.76 years, while DoD value decreases from 55% to 40%. So, the capital cost is deferred as 2.61 years, with a net saving of (2.61 x 6,600) €17,226.

Table 4.6 Comparison of results of problem no. 1 with different DoD level

DoD level (%)	Operational cost (€)	Battery cost C_{bat} (€)	Battery throughput (kWh)	Maximum battery life (years)
55	509.3745	25.2607	144.1437	7.15
50	510.4034	24.4052	142.4843	7.39
45	511.9696	21.4186	128.2500	8.44
40	513.6191	18.5081	114.0000	9.76

4.5 Conclusion

This study proposes an online energy management of the grid-connected stochastic microgrid operation. In order to achieve optimal economic operation, the rolling horizon control approach is presented by addressing the uncertainties of load demand and PV power generation. To validate the performance of the approach, deterministic and stochastic case studies are conducted. The results demonstrate that the RHC can provide 100% of optimality for the deterministic case and at least 99.94% of optimality for the stochastic case. The stochastic case was conducted with a random forecast error obtained from historical data, with a performance comparison made with MILP. The results show that the RHC approach can perform efficiently even in uncertain circumstances. This method integrates the operational costs of each asset in a microgrid, including the degradation cost of the battery, as well as the cost of the main grid and diesel generator. Besides the integration of the network and technical constraints, by adjusting the DoD

level of the battery, we can see that the battery life is extended by 2.61 years. Thus, the system's net saving related to its battery is estimated as €17,226.

Chapter 5

Optimal Control of Microgrids with Multi-stage Mixed-integer Nonlinear Programming Guided Q-learning Algorithm

This chapter proposes an energy management system (EMS) for the real-time operation of a pilot stochastic and dynamic microgrid on a university campus in Malta consisting of a diesel generator, photovoltaic panels, and batteries. The objective is to minimize the total daily operation costs, which include the degradation cost of batteries, the cost of energy bought from the main grid, the fuel cost of the diesel generator, and the emission cost. The optimization problem is modeled as a finite Markov Decision Process (MDP) through a combination of network and technical constraints, with Q-learning algorithm adopted to solve the sequential decision subproblems. The proposed algorithm decomposes a multi-stage mixed-integer nonlinear programming (MINLP) problem into a series of single-stage problems so that each subproblem can be solved by using Bellman's equation. To prove the effectiveness of the proposed algorithm, three case studies are taken into consideration: ① minimizing the daily energy cost, ② minimizing the emission cost, and ③ minimizing the daily energy cost and emission cost simultaneously. Moreover, each case is operated under different battery operation conditions to investigate the battery lifetime. Finally, performance comparisons are carried out with a conventional Q-learning algorithm.

5.1 Introduction

Distributed energy resources (DERs) such as wind power, solar power, and an energy storage system (ESS) are viewed as a solution due to the reduction in primary energy reserves and ever-increasing load demand. Thus, microgrids play a crucial role in the integration of DERs into future electric power grids. Despite the many advantages of microgrids, there are several technical challenges, such as stability and reliability issues caused by the natural uncertainty and unpredictability of renewable energy sources (RESs). The management of power system operation is already quite complex because instability and unreliability make it very difficult to maintain a balance between the supply and demand of energy in real-time operation. When integrating RESs into the power systems, the complicated systems get even more complex, rendering the management of power systems which include DERs a real challenge. It is crucial to have appropriate energy management in place for the success of such complicated power systems. A microgrid energy management system (EMS) plays a critical role in offering economic, sustainable and reliable operation by providing the optimal coordination between conventional energy resources, RESs, ESSs, and consumers.

The existing studies in the literature can be classified according to the objectives of EMSs or the optimization approaches used. Microgrid energy management has been studied for many purposes such as operation cost reduction [170, 183-185], maximization of battery life and renewable energy penetration [181], environmental pollution and operation cost reduction [161, 179, 202], and improvement of stability and reliability of the system [180, 203]. For example, while the main objective in [170] is to minimize the total operation cost of a microgrid by focusing on the fuel cost of power generators, the cost of operation and maintenance, the cost of purchasing electricity from main grid and penalties on the curtailment of renewable energy and load shedding, [181] intends to maximize the reliability and customer satisfaction.

The intermittent nature of RESs and the nonlinear characteristics of other devices make it inevitable to have an optimization process in place, as trivial straightforward decisions result in severely suboptimal management systems. In this regard, mathematical optimization methods like MILP and MINLP are used to obtain exact solutions to integer programming problems, while state-of-the-art solution algorithms still rely on implicit enumeration, which carries a large computational burden for practical problems. Hence, several heuristic algorithms are used for the power systems in the literature. The main

limitation of these heuristic algorithms is that they cannot guarantee optimality, nor can they provide bounds on the amount of suboptimality, i.e., the optimality gap.

The determination of the optimal operation involves a sequential decision-making process to tackle the uncertainty in weather-related generation units, as well as the demand, electricity price, and problems arising from the integration of variable power sources into the main grid. Thus, energy management for a microgrid becomes unavoidable to enable stable and reliable operation, seek optimal dispatch, and maximize its performance. To solve these issues, adaptive and intelligent methods are essential, especially for a large-scale microgrid. Reinforcement learning (RL) is a promising computational method for solving the stochastic sequential decision-making problems, in which a learning agent learns what actions to take by interacting with its environment to maximize a reward signal [188]. In this method, the agent is not told what to do in the current state, but instead needs to try the actions to find out which one gives the maximum reward. However, the RL suffers from the “curse of dimensionality” as the complexity of microgrid system increases. Due to the fact that coarse-grained discretization causes information loss, fine-grained discretization is required, and that causes the “curse of dimensionality” problem. Several studies have been published in the literature regarding RL. In [204], an RL-based optimal control method is proposed to improve the transient performance of hybrid microgrid systems. In [205], a well-known batch RL (fitted Q-iteration) for residential demand response is suggested. In [206], the fitted Q-iteration is also used on a residential scale to minimize the amount of imported power from the main grid.

In [207], a dynamic pricing strategy using a Q-learning (QL) algorithm is proposed by considering the hierarchical electricity market. The aim is to find a financial balance between the profits of service providers and costs of customers. In other words, customers, service providers, and main grids constitute the whole system. In [208], a strategic bidding is proposed by using a QL algorithm. In this study, customers need a bidding strategy to maximize their long-term profit. In [209], a two-step ahead RL method is proposed for a simple microgrid system to plan battery schedules without considering the detailed mathematical model of devices. In [210-212], a multi-agent RL method is applied to a microgrid considering the uncertainties. Moreover, operation cost reduction is targeted with an RL method in [159, 213].

This paper proposes an EMS that employs an MINLP guided QL algorithm for microgrid operation in a stochastic and dynamic environment to tackle the

aforementioned challenges. The main feature of the proposed algorithm is that the “curse of dimensionality” can be handled without coarse-grained discretization. The proposed algorithm decomposes the multi-time horizon optimization problem into sub-problems based on consecutive time-indexed periods. Then, each sub-component at each time is solved by the MINLP method. The purpose of the study is to minimize the total daily operation costs which include the degradation cost of batteries, the cost of energy bought from the main grid, the fuel cost of the diesel generator (DG), and the emission cost. Compared with prior studies (e.g., [136, 202, 207]), the main contributions of the paper are as follows:

- The proposed real-time EMS is formulated as a Markov decision process (MDP) problem, where the solar energy, DG and battery are considered. The proposed algorithm has been developed to provide efficient energy management of a real microgrid pilot of the Malta College of Arts, Science and Technology (MCAST) by considering the constraints of the network model and technical model.
- This paper tackles the problem with multiple smaller sub-problems by decomposing multiple time period operation cost optimization over a finite horizon. Thus, MINLP sub-problems can be solved effectively.
- In order to reduce the dependency on the forecasted information, the historical data are used offline to deal with uncertainties of load demand and photovoltaic (PV).
- The proposed algorithm enables finding optimal solutions without applying an approximation method, which enhances the performance of QL-based optimization with large state space.

5.2 Microgrid Model Description

The structure of the microgrid system is illustrated in Figure 5.1, where PCC stands for point of common coupling and SS stands for substation. The system is comprised of solar PV arrays (63 kW in total), a DG (300 kW), lithium-ion batteries (300 kWh capacity in total) and loads. This paper assumes that the microgrid operates in grid-connected mode. A finite time horizon of the microgrid operation is considered as $t = \{0, \Delta t, 2\Delta t, \dots, T - \Delta t, T\}$, where $\Delta t = 5$ min is the time interval and $T = 24$ hours.

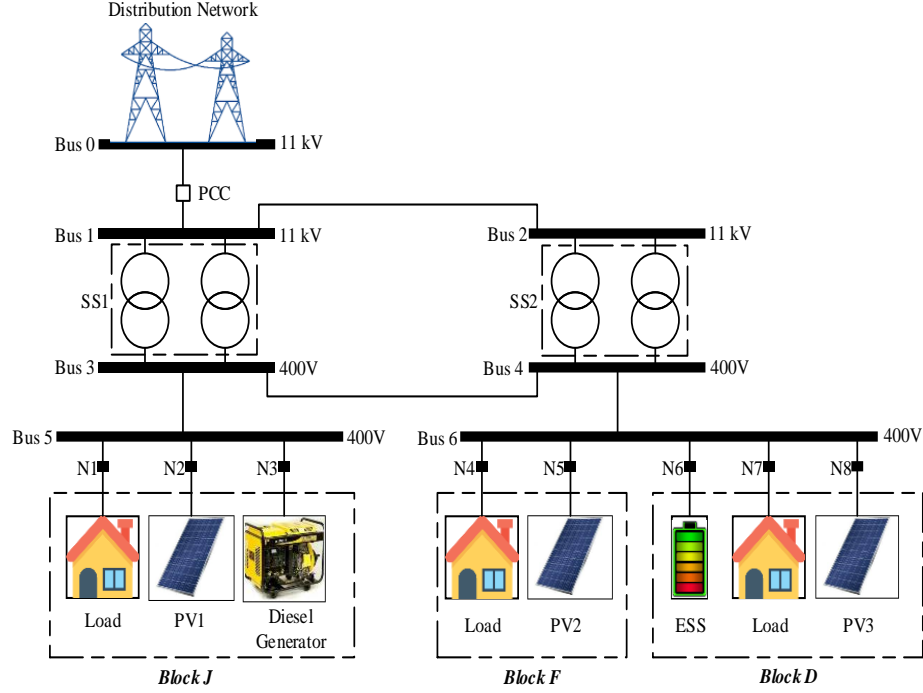

Figure 5.1 Schematic diagram of microgrid.

5.2.1 Battery Model

The ESS is one of the core parts of the microgrid system, which can improve its performance. Since the initial investment cost of batteries is high, it is crucial to extend the battery life. The battery cycle life is directly related to the depth of discharge (DoD). The cycle life data are given by the battery manufacturer in the form of total cycle number with respect to the DoD. The relationship between expected cycle life and DoD is exponential for the lithium-ion battery as given in (5.1).

$$L(D) = D^a e^b \quad (5.1)$$

where D is the DoD in percentage at which the battery is cycled; $L(D)$ is the average cycle number at that particular D ; and a and b are the battery dependent coefficients. From the logarithmic fitted curve between DoD and cycle life specified in the data sheet of the battery used, these coefficients are found as $a = -1.24$, $b = 7.043$. From the fitted curve, the battery wear cost can be calculated as:

$$C_w = \frac{C_{inv}}{2E_{max}L(D)D\eta^d\eta^c} \quad (5.2)$$

where C_{inv} is the capital cost of battery; E_{max} is the total capacity of battery; and η^c and η^d are the charging and discharging efficiencies, respectively.

The operation cost of battery based on wear cost is written as:

$$C_{bat} = C_W P_{bat,t} \Delta t \quad (5.3)$$

where $P_{bat,t}$ is the charging or discharging power of the battery at time t .

At any given time, the state of charge (SOC) of the lithium-ion battery system should be within a certain range. It can be expressed as:

$$SOC_{min} \leq SOC_t \leq SOC_{max} \quad (5.4)$$

where SOC_{min} and SOC_{max} are the lower limit and upper limit of SOC, respectively. The charging and discharging states, charging and discharging power limits, and SOC formulation of the lithium-ion battery are given respectively as follows:

$$u_{bat,t}^c + u_{bat,t}^d \leq 1 \quad (5.5)$$

$$u_{bat,t}^c, u_{bat,t}^d \in \{0,1\}$$

$$0 \leq P_{bat,t}^d \leq u_{bat,t}^d P_{max}^d \quad (5.6)$$

$$0 \leq P_{bat,t}^c \leq u_{bat,t}^c P_{max}^c \quad (5.7)$$

$$SOC_t = \begin{cases} SOC_{t-\Delta t} - \frac{P_{bat,t}^d \Delta t}{\eta^d \cdot E_{max}} & P_{bat,t}^d > 0 \\ SOC_{t-\Delta t} + \frac{\eta^c P_{bat,t}^c \Delta t}{E_{max}} & P_{bat,t}^c > 0 \end{cases} \quad (5.8)$$

where $u_{bat,t}^c$ and $u_{bat,t}^d$ are the charging and discharging states of the battery, respectively; $P_{bat,t}^c$ and $P_{bat,t}^d$ are the charging and discharging power of the battery, respectively; and P_{max}^c and P_{max}^d are the maximum charging and discharging power of the battery, respectively. η^c and η^d are both assumed to be 95%, according to the practical situation of the MCAST system.

5.2.2 Diesel Generator

The hourly fuel consumption FC_t of a DG is modeled as a linear function, which is based on data provided by the manufacturer.

$$FC_t = F_1 P_{rated} + F_2 P_{dg,t} \quad (5.9)$$

where F_1 and F_2 are the coefficients of fuel consumption function, which are set as 0.0183 and 0.22, respectively; and P_{rated} and $P_{dg,t}$ are the rated power and the actual output power of DG, respectively.

The power limits of DG are imposed as:

$$k P_{rated} \leq P_{dg,t} \leq P_{rated} \quad (5.10)$$

where k is set to be 0.3 based on the suggestion of manufacturers.

The fuel cost of DG at time step t can be calculated as:

$$C_{dg,t} = C_{fuel}FC_t\Delta t \quad (5.11)$$

where C_{fuel} is the fuel cost.

5.2.3 Main grid

The power transaction between main grid and microgrid should be constrained as:

$$-P_{grid}^{max} \leq P_{grid,t} \leq P_{grid}^{max} \quad (5.12)$$

where $P_{grid,t}$ is the active power exchange between microgrid and main grid at time t ; and P_{grid}^{max} is the maximum active power that can be exported to and imported from the main grid.

The cost related to the power transaction at time step t is:

$$C_{grid,t} = prc_t P_{grid,t} \Delta t \quad (5.13)$$

where prc_t is the real-time electricity price at time step t .

5.2.4 AC Power Flow

The power flow limits in each branch ij are considered as:

$$P_{ij,t} = \frac{|V_{i,t}^2| \cos(\theta_{ij})}{|Z_{ij}|} - \frac{|V_{i,t}| |V_{j,t}| \cos(\delta_{i,t} - \delta_{j,t} + \theta_{ij})}{|Z_{ij}|} \quad (5.14)$$

$$Q_{ij,t} = \frac{|V_{i,t}^2| \sin(\theta_{ij})}{|Z_{ij}|} - \frac{|V_{i,t}| |V_{j,t}| \sin(\delta_{i,t} - \delta_{j,t} + \theta_{ij})}{|Z_{ij}|} \quad (5.15)$$

$$P_{ij,t}^2 + Q_{ij,t}^2 \leq (S_{ij}^{max})^2 \quad (5.16)$$

where $i, j \in \{1, 2, \dots, N_b\}$, and N_b is the total number of buses; $P_{ij,t}$ and $Q_{ij,t}$ are the active and reactive power flows of branch ij , respectively; $|V_{i,t}|$ and $\delta_{i,t}$ are the voltage amplitude and angle at bus i , respectively; $|Z_{ij}|$ and θ_{ij} are the impedance magnitude and corresponding phase angle of branch ij , respectively; and S_{ij}^{max} is the maximum complex power flow of branch ij .

The transmission capacity limit of power cables is also considered as:

$$P_{ij,t} \leq P_{ij}^{max} \quad (5.17)$$

where P_{ij}^{max} is the maximum power flow limit from bus i to bus j .

The voltage amplitude limit is bounded by:

$$V_i^{min} \leq |V_{i,t}| \leq V_i^{max} \quad (5.18)$$

where V_i^{min} and V_i^{max} are the minimum and maximum voltage magnitudes of bus i , respectively.

The power balance equation is also considered as:

$$P_{pv,t} + P_{grid,t} + P_{dg,t} + (P_{bat,t}^d - P_{bat,t}^c) = P_{ij,t} + P_{L,t} \quad (5.19)$$

where $P_{pv,t}$ is the total active power output of PV arrays; and $P_{L,t}$ is the total active load demand.

5.2.5 Emission Cost Calculation

Toxic gas externalities including CO₂, NO_x, and SO₂ must be considered as cost function to reduce the greenhouse gas effect. The mass of the three gases is calculated with mathematical equation of the generated power of the DG and electricity grid as:

$$C_{em,t} = \sum_{k=1}^{N_{em}} \sum_{i=1}^{N_{ps}} EC_k \cdot EF_{ik} \cdot P_{i,t} \quad (5.20)$$

where N_{em} is the number of emission types (CO₂, NO_x, SO₂); N_{ps} is the number of power sources that release the toxic gases (main grid and DG); EC_k is the externality cost of emission type k ; EF_{ik} is the emission factor of power source i and the emission type k ; and $P_{i,t}$ is the power output of power source i .

5.3 MDP Model for Real-Time Scheduling of Microgrid

In the MDP model, there are four components: state variables, decision (action) variables, state transitions, and rewards. The state variables denote the current state of the system and the basis for making operation decisions. The decision variables identify the choices, while the agent selects an action from a set of available actions, which is then sent to the environment. A time step later, the agent receives a reward which is an evaluation of taken actions, and the environment responds to these actions as a new state transition. Clearly, MDP allows us to predict the next state and reward given the current state and action. The next state depends only on the states and actions at time t instead of the previous history.

The centralized EMS collects two types of information to make optimal decisions: the first is the historical data of PV generation and demand at the annual, monthly, daily, hourly and minute levels, and the second is the real-time information from microgrid assets including the SOC of the battery, electricity price, and the output of the battery and DG. Based on this information, EMS decides the power outputs of DG, PV, and battery,

as well as the power exchange between the main grid and microgrid, to achieve the objectives of this research.

5.3.1 State Variables and Decision (Action) Variables

The state variables S_t at time t include SOC_t , available active power outputs of PVs $P_{pv1,t}^a, P_{pv2,t}^a, P_{pv3,t}^a$, total active load demand $P_{L,t}$, and real-time electricity price prc_t . Hence, S_t can be given as:

$$S_t = \{SOC_t, P_{pv1,t}^a, P_{pv2,t}^a, P_{pv3,t}^a, P_{L,t}, prc_t\} \quad (5.21)$$

The decision variable x_t at time t of the problem can be given as:

$$x_t = \{P_{bat,t}^d, P_{bat,t}^c, P_{dg,t}\} \quad (5.22)$$

The transition function for the battery SOC can be formulated as:

$$SOC_{t+\Delta t} = SOC_t + \left(\frac{P_{bat,t}^d}{\eta^d} - P_{bat,t}^c \eta^c \right) \Delta t \quad (5.23)$$

5.3.2 Objective Function

The total cost of microgrid is considered as a trade-off between power generation cost and emission cost caused by the grid and DG. In this study, three case studies are considered including individual minimization of power generation cost, individual minimization of emission cost, and simultaneous minimization of power generation cost and emission cost. Thus, the objective function can be expressed as

$$C_t(S_t, x_t) = C_{bat,t}(S_t, x_t) + C_{dg,t}(S_t, x_t) + C_{grid,t}(S_t, x_t) + C_{em,t}(S_t, x_t) \quad (5.24)$$

where x_t is an action variable; and (S_t, x_t) is the state-action pair.

5.4 Proposed Optimization Model

The main advantage of the QL algorithm is that it does not need any environment model and can handle uncertainties and stochastic transitions without requiring full information of the system. However, it can be inefficient for large state-action space and cannot be applied easily to continuous state-action spaces involved in our problem. The simplest solution to a continuous working space is to discretize the space. Making discretization at smaller intervals can compensate for the changes of the system, but the state-action pair number will increase exponentially. In this study, after making discretization with larger intervals, each subproblem at each time step is solved by the

MINLP method using the DICOPT solver of General Algebraic Modeling System (GAMS) to get precise results. Thus, the problem can be handled with a MINLP-guided QL algorithm, without discretization in smaller way. In this way, it can overcome the challenges and find a more precise solution instead of an approximated value.

The complete training process of the proposed algorithm using a combination of QL algorithm and MINLP optimization is presented in Figure 5.2.

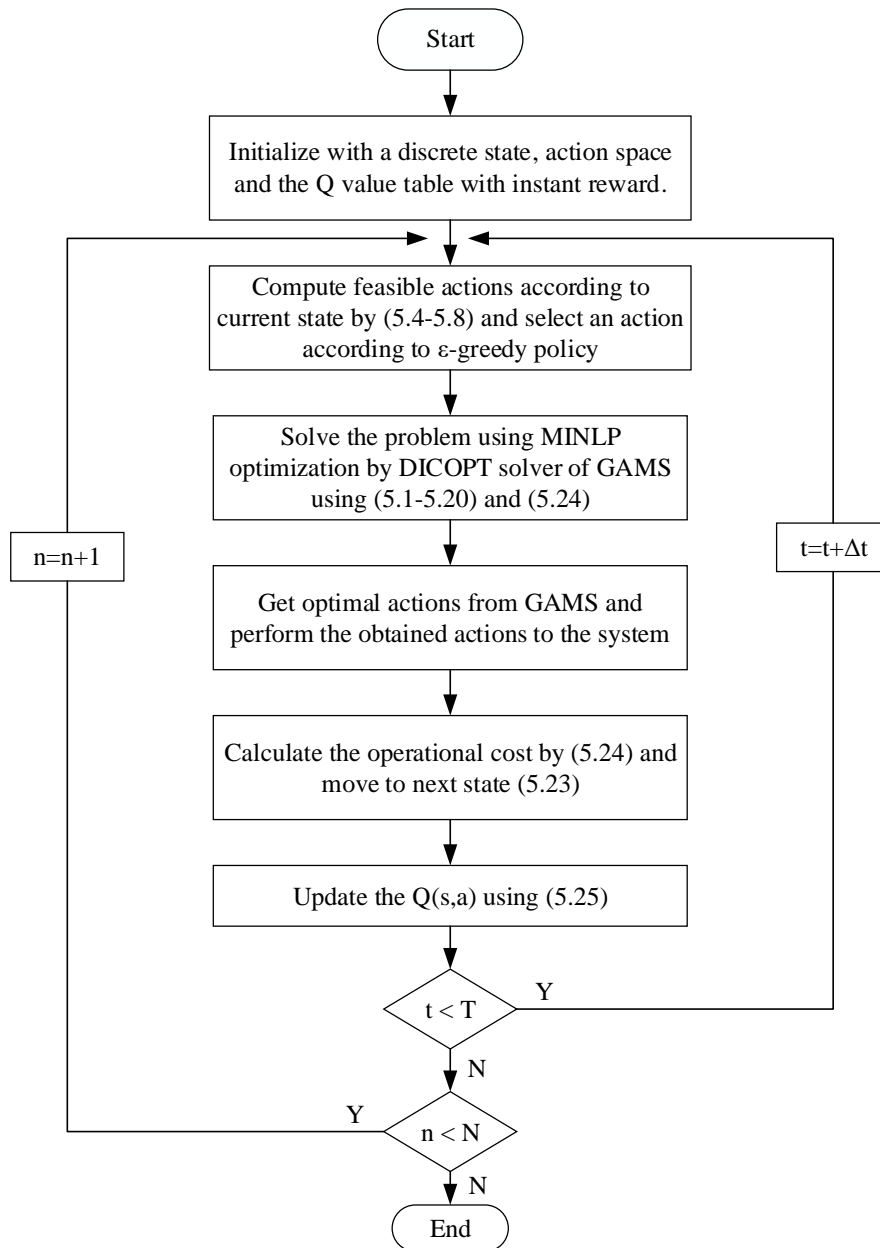

Figure 5.2 Flowchart of training process.

In the flowchart, a discrete state, the whole action space of the system and the Q -value table are initialized at the start. Instead of storing every state-action pair of the

system, iteration begins by choosing only a discrete state. Additionally, the $Q(S_t, x_t)$ values of each state-action pairs are initialized with the total discounted reward r_0 with $\gamma = 0$ to reduce the convergence time, which can be obtained as the instant reward at time step 0 before the learning process starts. Then, the iteration starts by finding feasible actions at that state. An action is then selected from the feasible action set using ϵ -greedy policy. The selected actions are sent to the GAMS to solve the economic dispatching problem as MINLP. Thus, GAMS that uses the discretized actions at large intervals as inputs will give us optimal actions that minimize the cost function. The obtained optimal actions are then performed in the microgrid system. In the next step, the objective function at time t is calculated using (5.24). Then, the $Q(S_t, x_t)$ value and time are updated, respectively. Finally, after the number of episode n is updated, if $n < N$, where N is the total number of episodes, the system goes to the next episode.

5.5 Numerical and Result Analysis

5.5.1 Simulation Environment

The microgrid is equipped with a 300 kW/375 kVA DG, 3×21 kW solar generators, and 150 kW/300 kWh battery, as shown in Figure 5.1 above. Moreover, the profiles of load demand and the electricity price are shown in Figures 5.3 and 5.4, respectively. The parameters of the DG and lithium-ion battery are given in Tables 5.1 and 5.2, respectively. The parameters of distribution lines are given in Table 5.3.

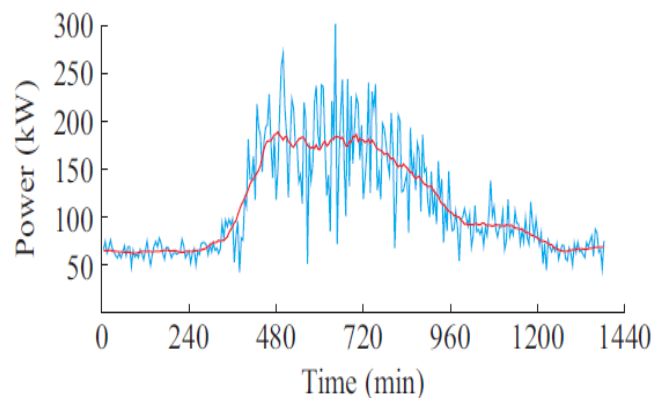

Figure 5.3 Profiles of load demand.

Table 5.1 Parameters of DG

Parameter	Value	Parameter	Value
P_{rated} (kW)	300	k	0.3
F_1 (L · h ⁻¹ · kW ⁻¹)	0.0183	C_{fuel} (€/L)	1.1
F_2 (L · h ⁻¹ · kW ⁻¹)	0.22		

Table 5.2 Parameters of lithium-ion battery

Parameter	Value	Parameter	Value
E_{max} (kWh)	300	P_{max}^d (kW)	50
Cycle life	2700 @50% DoD	P_{max}^c (kW)	40
η^d, η^c	0.95, 0.95	a	-1.24
SOC_{min} (%)	50	b	7.043
SOC_{max} (%)	100	Battery Cost (€/kWh)	220

Table 5.3 Parameters of distribution lines

Line		Resistance	Reactance
From	To	(mΩ)	(mΩ)
Bus 0	Bus 1	129	78.225
Bus 1	Bus 2	19.737	11.969
Bus 3	Bus 4	11.536	12.208
Bus 3	Bus 5	3.770	3.989
Bus 4	Bus 6	3.770	3.989
Bus 5	N1	3.770	3.989
Bus 5	N2	3.770	3.989
Bus 5	N3	3.770	3.989
Bus 6	N4	9.048	9.550
Bus 6	N5	9.048	9.550
Bus 6	N6	4.901	5.186
Bus 6	N7	6.786	7.181
Bus 6	N8	6.786	7.181

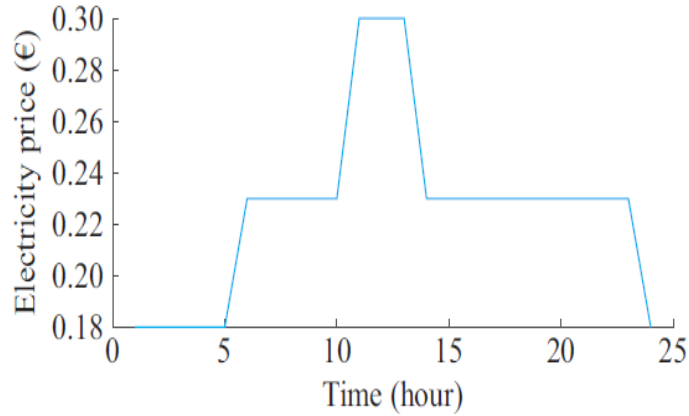

Figure 5.4 Profile of electricity price

For all simulation cases, since the SOC changes from 40% to 60%, it is discretized into 70 to 130 states. The discharging/charging power of the battery, the output power of DG, the generated PV power and the load demand are discretized into 10/8 states, 7 states, 5 states, 60 states, respectively. Table 5.4 demonstrates the externality costs and emission factors of the main grid and DG. The optimization horizon of all simulations is set at 24 hours, and $\Delta t = 5$ min. Although the time interval is five minutes in the operation of the algorithm, the results in all cases are drawn with a time interval of one hour so that the graphics can be clearly seen. All studies have been simulated using MATLAB 2020 and GAMS 24.9.2 on a 64-bit Linux based computer with 250 GB of RAM and a 2.10 GHz Intel® Xeon® processor.

Table 5.4 Parameters of externality costs and emission factors of DG and main grid

Emission type	Externality cost (€/kg)	Emission factors of DG (kg/kWh)	Emission factors of main grid (kg/kWh)
CO_2	0.0308	0.743	0.922
SO_2	2.181	4.045×10^{-4}	3.583×10^{-3}
NO_x	9.2527	9.36×10^{-3}	2.295×10^{-3}

5.5.2 Case Studies

5.5.2.1 Case 1: Minimize Operation Cost without Emission Cost

In this case, the main objective is to minimize the operation costs of the battery, DG and main grid. The emission costs were not considered. When the battery is operated at SOC of 50%, the simulation results are illustrated in Figure 5.5.

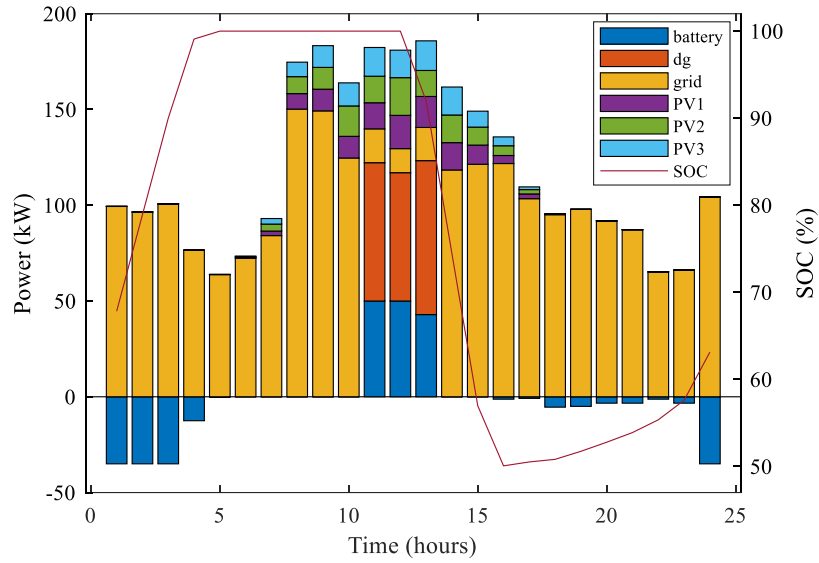

Figure 5.5 Output power of all sources for Case 1

It can be observed from Figure 5.5 that the battery stores energy during the 0th-4th hour. Then the power generated by PV is dispatched. When the operation cost of DG is less than the electricity price, DG is turned on between the 11th-13th hour. Since DG is operated at minimum 90 kW, the power can be bought from the main grid in that situation. Table 5.5 shows the effect of battery SOC on the average daily operation cost.

Table 5.5 Simulation results of proposed algorithm compared with QL algorithm for Case 1

SOC (%)	40		45		50		55		60	
	<i>G-QL</i>	<i>C-QL</i>	<i>G-QL</i>	<i>C-QL</i>	<i>G-QL</i>	<i>C-QL</i>	<i>G-QL</i>	<i>C-QL</i>	<i>G-QL</i>	<i>C-QL</i>
Total										
emission (kg/kWh)	2139.04	2161.46	2150.28	2161.50	2153.69	2163.93	2163.85	2165.2087	2171.6735	2178.3315
Emission Cost (€)	129.6250	130.8125	130.2584	132.0833	133.8653	134.1898	134.1640	135.3101	136.1739	137.3908
Battery throughput (kWh)	150.0000	142.0833	150.0000	142.0833	142.9167	142.0833	129.5833	128.2500	115.4167	114.0000
Daily energy cost (€)	547.3606	554.4926	550.6309	556.9808	555.4273	558.2455	555.6116	558.5268	558.2421	561.9658

When the battery is operated at SOC of 40%, the average daily operation cost is €547.3606, while it goes up to €558.2421 at SOC of 60%. According to this table, the proposed algorithm performs better than the QL algorithm on the average daily operation

cost. If we assume that the battery is operated at that power level on average during a year, by changing the SOC level from 40% to 60%, the battery life increases from 6.71 years to 9.65 years. In this way, the capital cost of the battery is deferred as 2.94 years, if we assume the average lithium-ion battery life as ten years and the total capital cost of battery as (300×220) €66,000. The annual cost throughout the life of the battery is €6,600. Thus, the net saving of battery renewal is (2.94×6600) €19,404.

4.5.2.2 Case 2: Minimize Operation Cost with Emission Cost

DG is not used in this case, because the total cost of the DG (including the fuel cost and emission cost) is higher than that of the main grid. The simulation results are illustrated in Figure 5.6. As in Case 1, the battery charges at low electricity price intervals and discharges at peak price intervals to support the load demand.

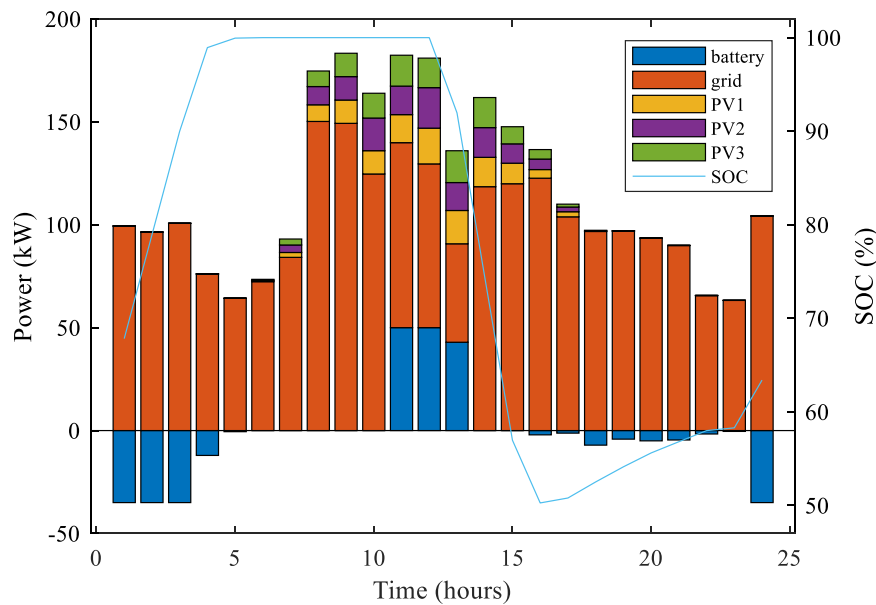

Figure 5.6 Output power of all sources for Case 2

Table 5.6 shows the results of the proposed algorithm and QL algorithm according to different SOC values. It can be seen from Table 5.6 that the proposed algorithm works better than the QL algorithm. Comparing Table 5.6 with Table 5.5, it can be seen that for the proposed algorithm, the emission cost decreases by 5.68% (7.97%), while the daily energy cost increases by 0.66% (0.37%) with SOC of 40% (60%).

Table 5.6 Simulation results of proposed algorithm compared with QL algorithm for Case 2

SOC (%)	40		45		50		55		60	
	<i>G-QL</i>	<i>C-QL</i>	<i>G-QL</i>	<i>C-QL</i>	<i>G-QL</i>	<i>C-QL</i>	<i>G-QL</i>	<i>C-QL</i>	<i>G-QL</i>	<i>C-QL</i>
Total										
emission (kg/kWh)	2167.85	2192.75	2179.91	2194.68	2189.63	2199.13	2202.16	2208.6829	2211.7894	2220.3729
Emission Cost (€)	122.2626	123.6544	122.9418	123.7633	123.4897	124.0138	124.1954	124.5518	125.3180	125.7182
Battery throughput (kWh)	150.0000	141.6667	150.0000	141.6667	142.9167	141.6667	129.5000	128.2500	115.8333	114.0000
Daily energy cost (€)	550.9850	557.6795	554.5246	558.7408	556.5094	559.6482	558.7096	560.8216	560.3257	563.0461

4.5.2.3 Case 3: Minimize Emission Cost

Figure 5.7 shows the dispatched power by the proposed algorithm considering the goal of reducing the emission cost. According to the figure, the microgrid system uses the maximum capacity of renewable sources since they have no emission. Since the emission cost of the main grid is less than that of the DG, the whole day demand is supplied by the main grid, and the battery also contributes to supply the demand. It can be observed clearly from Figure 5.7 that the battery charging and discharging states are constantly changing, which adversely affects battery life.

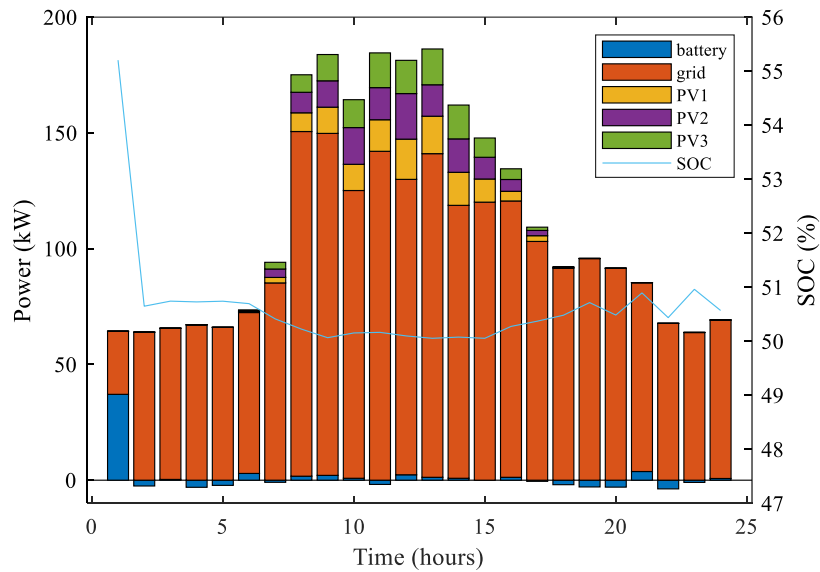

Figure 5.7 Output power of all sources for Case 3

Based on Table 5.7, the battery lifetime can be calculated, which varies from 5.32 to 7.03 years as the SOC value of the battery increases. Thus, the capital cost of the battery renewal is deferred for 1.71 years and the net saving is (1.71×6600) €11286. Comparing this figure with that of Case 1, the net saving decreases by 41.84%.

Table 5.7 Simulation results of proposed algorithm compared with QL algorithm for Case 3

SOC (%)	40		45		50		55		60	
	<i>G-QL</i>	<i>C-QL</i>	<i>G-QL</i>	<i>C-QL</i>	<i>G-QL</i>	<i>C-QL</i>	<i>G-QL</i>	<i>C-QL</i>	<i>G-QL</i>	<i>C-QL</i>
Total emission (kg/kWh)	2102.03	2108.02	2120.36	2124.43	2129.73	2137.03	2147.73	2152.8422	2162.6823	2165.4063
Emission cost (€)	118.4323	118.7715	119.4620	119.6959	119.9896	120.4056	121.0038	121.2964	121.8460	122.0151
Battery throughput (kWh)	189.0191	187.2234	181.2250	177.4557	184.4583	172.8813	169.3868	162.4661	158.3448	148.6896
Daily energy cost (€)	555.8055	557.9767	559.4833	560.4852	561.9195	562.8523	563.6109	564.7938	565.7577	568.3321

Table 5.8 shows the emission cost and daily energy cost comparison of the three cases for with SOC of 50% the proposed algorithm.

Table 5.8 Emission cost and daily energy cost comparison for three cases with SOC of 50%

	Emission Cost (€)	Daily Energy Cost (€)	Total Cost (€)
Case 1	133.8633	555.4273	689.2906
Case 2	123.4897	556.5094	679.9991
Case 3	119.9896	561.9195	681.9090

It can be seen that the emission cost in Case 3 decreases by 10.364% compared to Case 1. However, in Case 3, the daily energy cost is higher than the other cases since only the emission cost is taken into consideration. Case 2 provides a relatively balanced result compared with the other two cases in terms of daily energy cost and emission cost. As both emission cost and energy cost are tried to be minimized, the total operation cost is the lowest in Case 2.

5.6 Conclusion

This paper proposes an MINLP guided QL algorithm for the real-time energy management of the stochastic and dynamic microgrid in Malta. The AC power flow equations and constraints, the battery wear cost and constraints, the fuel cost, and the emission cost are considered for the economic and environment-friendly operation of the microgrid system. Three different cases are considered with three different objective functions: ① minimization of daily operation cost regardless of emission cost, ② minimization of both daily energy cost and emission cost, and ③ minimization of emission cost without considering daily energy cost. The simulation results, using real pilot data of MCAST, prove the cost effectiveness of the proposed algorithm compared with the traditional QL algorithm. In case studies using the proposed algorithm, there is a 1.348% reduction in the daily total operation cost (in Case 2 compared with Case 1). The daily total operation cost of the proposed algorithm is up to 1.25% lower than that of the QL algorithm. From the simulation results, we can also find that the battery lifetime is affected by the adjustment of the battery's SOC value.

Chapter 6

Conclusions and Future Prospects

6.1 Conclusions

Electricity is the largest contributor to the modern way of life. It has become impossible to imagine a day without it. Moreover, it must be said that mankind owes the increase in living standards throughout history largely to electricity. Therefore, operating an electricity system with high reliability and stability is extremely crucial to prevent/reduce the consumer from being affected by any disturbance. With the increasing electricity demand and reduction of fossil fuels necessary for electricity generation, researchers have turned to nature to provide a solution. The abundance and clean nature of renewable energy sources have allowed the development of the existing electricity system. Therefore, microgrids become an important factor in ensuring electricity reaches the customers. This research has developed methodologies to overcome potential problems related to the penetration of renewable energy sources to the main electricity network. The interoperability of the microgrid and distribution network has been made more secure and robust through optimization.

This thesis demonstrates the energy management of a microgrid consisting of renewable energy sources, loads, and a battery. Three optimization methods were used to manage the microgrid. The objective function of the present microgrid management used the mixed integer linear programming (MILP), rolling horizon control (RHC) and Q-learning optimization methods to control the operation of the renewable energy sources, diesel generator, and battery. The formulations of the network model and of the technical model have been considered for the economic and environmental operation of the microgrid system to solve the optimization problem under more real-world conditions. The results and conclusions of each chapter have been presented separately at the end of each chapter. Therefore, the work presented in this thesis is summarized in this section.

In Chapter 1, the reports published by IEA were investigated to show the course of electricity production, consumption, and carbon dioxide production from electricity generation. Moreover, the effects of global warming on electricity systems and the need for a transition to clean energy have been explained, including the various difficulties and complexity it brings.

In Chapter 2, a literature review related to microgrid has been provided, including the microgrid concept, architectural models of microgrid, functions of smart grid components, challenges, and opportunities.

In Chapter 4, dynamic rolling horizon control has been proposed to achieve optimal economic operation by addressing the uncertainties of demand and PV power generation. The algorithm was tested on both stochastic and deterministic environments with 98% and 100% optimality respectively. The performance comparison has been made with the MILP and myopic approach. Moreover, the effect of battery life was investigated by operating at different DoD levels.

In Chapter 5, a Mixed Integer Nonlinear Programming (MINLP) guided Q-learning algorithm has been proposed for smart microgrid operation, which improves the vanilla Q-learning based optimization performance with large state-space. The proposed algorithm decomposes a multi-stage MINLP problem into a series of single-stage problems so that each subproblem can be solved. The proposed model has been implemented as three case studies with different objectives. Moreover, each case is operated under different battery operation conditions to investigate the battery lifetime. Finally, performance comparisons are carried out with a conventional Q-learning algorithm.

Publications from the studies presented in this dissertation are given in the curriculum vitae at the end of the thesis.

6.2 Societal Impact and Contribution to Global Sustainability

The environmental benefits of microgrids are generally related to emissions released during power generation. Around the world, 63.9% of electricity production was provided from fossil fuels in 2018. Since more than of the electricity generation has been

provided by fossil fuels, the energy-based greenhouse gas (GHG) emission increased from 20.5 GtCO₂ to 33.3 GtCO₂ between 1900 and 2019. With the increase of GHG emission, climate change has become an increasing threat.

To that point, microgrids are a great opportunity to use renewable energy sources or low carbon sources efficiently. In these times when global warming is an increasing threat, microgrids play an important role in the integration of renewable energy sources to the main electricity system. This thesis focuses on toxic gases containing CO₂, NO_x, and SO₂ to reduce the greenhouse gas effect.

In terms of social benefits, it is well suited to establish microgrids in underdeveloped regions where the electricity infrastructure is insufficient or where the infrastructure is not available. In this way, the problem of people who have difficulty in accessing electricity will be solved. They will also benefit economically by using renewable energy sources.

In addition to all those environmental and social benefits, this thesis is strongly connected and related to the seventh United Nation's Sustainable Development Goal titled "Ensure access to affordable, reliable, sustainable and modern energy for all", and corresponds to its targets 7.1 and 7.2. Considering the indicators of Target 7.1, microgrid construction will increase the proportion of the population with access to electricity. In addition, the ratio of the population which relies on clean fuels and technology will increase, achieving the second indicator of Target 7.1.

As the second target (7.2) which is "By 2030, increase substantially the share of renewable energy in the global energy mix", the thesis will contribute the literature in terms of the construction of microgrids and their benefits to the main grid for sharing renewable energy with the total final global energy consumption rate.

6.3 Future Prospects

To extend the current work, a summary of possible future research directions is summarized as follows:

1. Grid-connected mode is assumed in this research. For future research, adopting the scheme for islanded mode can be examined.
2. The microgrid system model used in this thesis can be diversified with electrical vehicle, controllable loads, etc.

3. Instead of the value-based reinforcement learning methods used in this thesis, policy-based reinforcement learning methods can be used with continuous action space.
4. Deep value-based and policy-based reinforcement learning algorithms method can be applied with large state-action space problem causing memory and computational complexity problem.

BIBLIOGRAPHY

- [1] International Energy Agency (IEA), “Electricity Information: Overview (2020 Edition),” *Data Publ. Stat. Rep.*, pp. 1–10, 2020, [Online]. Available: <https://webstore.iea.org/electricity-information-2019>.
- [2] EIA Energy Atlas, “World energy statistics & World energy balances,” p. 703, 2020, [Online]. Available: <http://data.iea.org/payment/products/103-world-energy-statistics-and-balances-2018-edition-coming-soon.aspx>.
- [3] IEA, “Global CO2 emissions in 2019,” Paris, 2020. [Online]. Available: <https://www.iea.org/articles/global-co2-emissions-in-2019>.
- [4] I. Energy and A. Iea, “Climate Resilience,” *Encycl. GIS*, pp. 216–216, 2017, doi: 10.1007/978-3-319-17885-1_101556.
- [5] International Energy Agency, “Renewables Information - Overview (2020 Edition),” *IEA Stat.*, p. 497, 2020, [Online]. Available: http://www.oecd-ilibrary.org/energy/renewables-information-2011_renew-2011-en.
- [6] IEA, “Renewables 2019 – Analysis - IEA,” *Int. Energy Agency*, p. 204, 2019, [Online]. Available: <https://www.iea.org/reports/renewables-2019>.
- [7] IEA (International Energy Agency), “World Energy Outlook 2018: Highlights,” *Int. Energy Agency*, vol. 1, pp. 1–661, 2018, [Online]. Available: https://www.oecd-ilibrary.org/energy/world-energy-outlook-2018/executive-summary_weo-2018-2-en.
- [8] H. Gharavi and R. Ghafurian, “Smart Grid: The Electric Energy System of the Future,” *Proc. Ieee*, vol. 99, no. 6, pp. 917–921, 2011, doi: 10.1109/Jproc.2011.2124210.
- [9] E. R. G. for E. and Gas, “Position Paper on Smart Grids - An ERGEG Conclusions Paper,” Brussels, 2010.
- [10] J. Joy, D. E. A. Jasmin, and V. R. John, “Challenges of Smart Grid,” *Int. J. Adv. Res. Electr. Electron. Instrum. Eng.*, vol. 2, no. 3, pp. 976–981, 2013, [Online]. Available: http://www.ijareeie.com/upload/march/4_Challenges_of.pdf.
- [11] T. L. Vandoorn and L. Vandeveld, “Contribution of Microgrids to the Development of the Smart Grid,” in *Smart grids, Clouds, Communications, Open Source, and Automation*, 1st ed., CRC Press, 2014, pp. 191–211.
- [12] J. J. Justo, F. Mwasilu, J. Lee, and J. W. Jung, “AC-microgrids versus DC-microgrids with Distributed Energy Resources: A Review,” *Renew. Sustain. Energy Rev.*, vol. 24, pp. 387–405, 2013, doi: 10.1016/j.rser.2013.03.067.
- [13] I. Patrao, E. Figueres, G. Garcera, and R. Gonzalez-Medina, “Microgrid Architectures for Low Voltage Distributed Generation,” *Renew. Sustain. Energy Rev.*, vol. 43, pp. 415–424, 2015, doi: 10.1016/j.rser.2014.11.054.
- [14] E. Planas, J. Andreu, J. I. Garate, I. M. de Alegria, and E. Ibarra, “AC and DC Technology in Microgrids: A Review,” *Renew. Sustain. Energy Rev.*, vol. 43, pp. 726–749, 2015, doi: 10.1016/j.rser.2014.11.067.
- [15] M. A. Tavakkoli, A. Radan, and H. Hassibi, “Simulation and Analysis of a Compact Electronic Infrastructure for DC Micro-Grid: Necessity and Challenges,” *Smart Grid Renew. Energy*, vol. 3, no. 2, pp. 73–82, 2012, [Online]. Available: <http://www.scirp.org/journal/PaperInformation.aspx?PaperID=19268>.
- [16] H. Kakigano, Y. Miura, and T. Ise, “Low-Voltage Bipolar-Type DC Microgrid for Super High Quality Distribution,” *Ieee Trans. Power Electron.*, vol. 25, no. 12, pp. 3066–3075, 2010, doi: 10.1109/Tpel.2010.2077682.

- [17] G. Q. Ding, F. Gao, S. Zhang, P. C. Loh, and F. Blaabjerg, "Control of Hybrid AC/DC Microgrid Under Islanding Operational Conditions," *J. Mod. Power Syst. Clean Energy*, vol. 2, no. 3, pp. 223–232, 2014, doi: 10.1007/s40565-014-0065-z.
- [18] E. Unamuno and J. A. Barrena, "Hybrid ac/dc microgrids-Part I: Review and classification of topologies," *Renew. Sustain. Energy Rev.*, vol. 52, no., pp. 1251–1259, 2015, doi: 10.1016/j.rser.2015.07.194.
- [19] E. Hossain, E. Kabalci, R. Bayindir, and R. Perez, "A Comprehensive Study on Microgrid Technology," *Int. J. Renew. Energy Res.*, vol. 4, no. 4, pp. 1094–1107, 2014, [Online]. Available: <http://dergipark.ulakbim.gov.tr/ijrer/article/viewFile/5000174167/5000157047>.
- [20] M. R. B. Magadam and S. S. S. Kumbar, "A Review of Recent Developments in Micro Grid," *Int. Ref. J. l Eng. Sci.*, pp. 6–9, 2012, [Online]. Available: <http://www.irjes.com/Conference/Raee/B0609.pdf>.
- [21] A. M. Bouzid, J. M. Guerrero, A. Cheriti, M. Bouhamida, P. Sicard, and M. Benghanem, "A Survey on Control of Electric Power Distributed Generation Systems for Microgrid Applications," *Renew. Sustain. Energy Rev.*, vol. 44, pp. 751–766, 2015, doi: 10.1016/j.rser.2015.01.016.
- [22] S. Koochi-Kamali, V. V. Tyagi, N. A. Rahim, N. L. Panwar, and H. Mokhlis, "Emergence of energy storage technologies as the solution for reliable operation of smart power systems: A review," *Renewable and Sustainable Energy Reviews*, vol. 25. Pergamon, pp. 135–165, Sep. 01, 2013, doi: 10.1016/j.rser.2013.03.056.
- [23] V. A. Boicea, "Energy storage technologies: The past and the present," *Proc. IEEE*, vol. 102, no. 11, pp. 1777–1794, 2014, doi: 10.1109/JPROC.2014.2359545.
- [24] N. K. C. Nair and N. Garimella, "Battery energy storage systems: Assessment for small-scale renewable energy integration," *Energy Build.*, vol. 42, no. 11, pp. 2124–2130, Nov. 2010, doi: 10.1016/j.enbuild.2010.07.002.
- [25] X. G. Tan, Q. M. Li, and H. Wang, "Advances and Trends of Energy Storage Technology in Microgrid," *Int. J. Electr. Power Energy Syst.*, vol. 44, no. 1, pp. 179–191, 2013, doi: 10.1016/j.ijepes.2012.07.015.
- [26] C. A. Hill, M. C. Such, D. Chen, J. Gonzalez, and W. M. K. Grady, "Battery energy storage for enabling integration of distributed solar power generation," *IEEE Trans. Smart Grid*, vol. 3, no. 2, pp. 850–857, 2012, doi: 10.1109/TSG.2012.2190113.
- [27] R. Arghandeh, M. Pipattanasomporn, and S. Rahman, "Flywheel energy storage systems for ride-through applications in a facility microgrid," *IEEE Trans. Smart Grid*, vol. 3, no. 4, pp. 1955–1962, 2012, doi: 10.1109/TSG.2012.2212468.
- [28] B. Zhao, X. Zhang, and J. Chen, "Integrated microgrid laboratory system," *IEEE Trans. Power Syst.*, vol. 27, no. 4, pp. 2175–2185, 2012, doi: 10.1109/TPWRS.2012.2192140.
- [29] F. Díaz-González, A. Sumper, O. Gomis-Bellmunt, and R. Villafáfila-Robles, "A review of energy storage technologies for wind power applications," *Renewable and Sustainable Energy Reviews*, vol. 16, no. 4. Pergamon, pp. 2154–2171, May 01, 2012, doi: 10.1016/j.rser.2012.01.029.
- [30] M. G. Molina, "Control design and simulation of supercapacitor energy storage for microgrid applications," *2014 IEEE PES Transm. Distrib. Conf. Expo. PES T D-LA 2014 - Conf. Proc.*, vol. 2014-Octob, pp. 8–13, 2014, doi: 10.1109/TDC-LA.2014.6955257.
- [31] G. Brando, A. Dannier, A. Del Pizzo, L. P. Di Noia, and C. Pisani, "Grid connection of wave energy converter in heaving mode operation by supercapacitor storage technology," *IET Renew. Power Gener.*, vol. 10, no. 1, pp. 88–97, 2016,

- doi: 10.1049/iet-rpg.2015.0093.
- [32] P. F. Ribeiro, B. K. Johnson, M. L. Crow, A. Arsoy, and Y. Liu, “Energy storage systems for advanced power applications,” in *Proceedings of the IEEE*, 2001, vol. 89, no. 12, pp. 1744–1756, doi: 10.1109/5.975900.
- [33] M. G. Molina, “Distributed energy storage systems for applications in future smart grids,” *Proc. 2012 6th IEEE/PES Transm. Distrib. Lat. Am. Conf. Expo. T D-LA 2012*, no. 0162, pp. 1–7, 2012, doi: 10.1109/TDC-LA.2012.6319051.
- [34] T. A. Nguyen, M. L. Crow, and A. C. Elmore, “Optimal sizing of a vanadium redox battery system for microgrid systems,” *IEEE Trans. Sustain. Energy*, vol. 6, no. 3, pp. 729–737, 2015, doi: 10.1109/TSTE.2015.2404780.
- [35] X. Qiu, T. A. Nguyen, J. D. Guggenberger, M. L. Crow, and A. C. Elmore, “A field validated model of a vanadium redox flow battery for microgrids,” *IEEE Trans. Smart Grid*, vol. 5, no. 4, pp. 1592–1601, 2014, doi: 10.1109/TSG.2014.2310212.
- [36] S. M. Mueeen, H. M. Hasanien, and J. Tamura, “Reduction of frequency fluctuation for wind farm connected power systems by an adaptive artificial neural network controlled energy capacitor system,” *Iet Renew. Power Gener.*, vol. 6, no. 4, pp. 226–235, 2012, doi: 10.1049/iet-rpg.2010.0126.
- [37] S. M. Mueeen, J. Tamura, and Toshiaki Murata, *Stability Augmentation of a Grid-connected Wind Farm*, 1st ed. London: Springer-Verlag London, 2009.
- [38] N. W. A. Lidula and A. D. Rajapakse, “Microgrids Research: A Review of Experimental Microgrids and Test Systems,” *Renew. Sustain. Energy Rev.*, vol. 15, no. 1, pp. 186–202, 2011, doi: 10.1016/j.rser.2010.09.041.
- [39] L. Hernandez *et al.*, “A Survey on Electric Power Demand Forecasting: Future Trends in Smart Grids, Microgrids and Smart Buildings,” *Ieee Commun. Surv. Tutorials*, vol. 16, no. 3, pp. 1460–1495, 2014, doi: 10.1109/Surv.2014.032014.00094.
- [40] M. E. Khodayar and H. Wu, “Demand Forecasting in the Smart Grid Paradigm: Features and Challenges,” *Electr. J.*, vol. 28, no. 6, pp. 51–62, 2015, [Online]. Available: <http://www.sciencedirect.com/science/article/pii/S1040619015001268>.
- [41] A. R. Khan, A. Mahmood, A. Safdar, Z. A. Khan, and N. A. Khan, “Load Forecasting, Dynamic Pricing and DSM in Smart Grid: A Review,” *Renew. Sustain. Energy Rev.*, vol. 54, no., pp. 1311–1322, 2016, doi: 10.1016/j.rser.2015.10.117.
- [42] C. Bennett, R. A. Stewart, and J. W. Lu, “Autoregressive with Exogenous Variables and Neural Network Short-Term Load Forecast Models for Residential Low Voltage Distribution Networks,” *Energies*, vol. 7, no. 5, pp. 2938–2960, 2014, doi: 10.3390/en7052938.
- [43] B. Hayes, J. Gruber, and M. Prodanovic, “Short-Term Load Forecasting at the Local Level using Smart Meter Data,” *IEEE PowerTech*. Eindhoven, pp. 1–6, 2015, [Online]. Available: <http://ieeexplore.ieee.org/xpl/articleDetails.jsp?arnumber=7232358&newsearch=true&queryText=Short-Term Load Forecasting at the Local Level using Smart Meter Data>.
- [44] S. R. Twanabasu and B. A. Bremdal, “Load Forecasting in a Smart Grid Oriented Building,” *CIREC*. Stockholm, pp. 1–4, 2013, [Online]. Available: http://ieeexplore.ieee.org/xpls/abs_all.jsp?arnumber=6683600&tag=1.
- [45] L. Hernandez *et al.*, “Artificial Neural Network for Short-Term Load Forecasting in Distribution Systems,” *Energies*, vol. 7, no. 3, pp. 1576–1598, 2014, doi: 10.3390/en7031576.

- [46] N. Tang and D. J. Zhang, "Application of a Load Forecasting Model Based on Improved Grey Neural Network in the Smart Grid," *Proc. ICSGCE*, vol. 12. Chengdu, China, pp. 180–184, 2011, doi: 10.1016/j.egypro.2011.10.025.
- [47] Y. Wang, D. Niu, and L. Ji, "Short-term Power Load Forecasting based on IVL-BP Neural Network Technology," *Complexity Science & Inf. Eng.*, vol. 4. Canada, pp. 168–174, 2012.
- [48] C. E. Borges, Y. K. Penya, and I. Fernandez, "Evaluating Combined Load Forecasting in Large Power Systems and Smart Grids," *Ieee Trans. Ind. Informatics*, vol. 9, no. 3, pp. 1570–1577, 2013, doi: 10.1109/Tii.2012.2219063.
- [49] M. Zeng, S. Xue, Z. J. Wang, X. L. Zhu, and G. Zhang, "Short-term Load Forecasting of Smart Grid Systems by Combination of General Regression Neural Network and Least Squares-Support Vector Machine Algorithm Optimized by Harmony Search Algorithm Method," *Appl. Math. Inf. Sci.*, vol. 7, no. 1L, pp. 291–298, 2013.
- [50] Z. A. Bashir and M. E. El-Hawary, "Short-term Load Forecasting using Artificial Neural Networks based on Particle Swarm Optimization Algorithm," *CCECE*. Vancouver, BC, pp. 272–275, 2007, [Online]. Available: [http://ieeexplore.ieee.org/xpl/articleDetails.jsp?arnumber=4232733&queryText=Short-term load forecasting using artificial neural networks based on particle swarm optimization algorithm&newsearch=true](http://ieeexplore.ieee.org/xpl/articleDetails.jsp?arnumber=4232733&queryText=Short-term+load+forecasting+using+artificial+neural+networks+based+on+particle+swarm+optimization+algorithm&newsearch=true).
- [51] A. Jain and M. B. Jain, "Fuzzy Modeling and Similarity based Short Term Load Forecasting using Swarm Intelligence-A step towards Smart Grid," in *Proceedings of Seventh International Conference on Bio-Inspired Computing: Theories and Applications (Bic-Ta 2012)*, vol. 202, Springer India, 2013, pp. 15–27.
- [52] R. Weron, "Electricity Price Forecasting: A Review of the State-of-the-art with a Look Into the Future," *Int. J. Forecast.*, vol. 30, no. 4, pp. 1030–1081, 2014, doi: 10.1016/j.ijforecast.2014.08.008.
- [53] A. Motamedi, H. Zareipour, and W. D. Rosehart, "Electricity Price and Demand Forecasting in Smart Grids," *IEEE Trans. Smart Grid*, vol. 3, no. 2, pp. 664–674, 2012, doi: 10.1109/Tsg.2011.2171046.
- [54] Q. Zhou, W. Guan, and W. Sun, "Impact of Demand Response Contracts on Load Forecasting in a Smart Grid Environment," *IEEE Power and Energy Soc. Gen. Meeting*. San Diego, CA, pp. 1–4, 2012.
- [55] Z. W. Zheng, Y. Y. Chen, M. M. Huo, and B. Zhao, "An Overview: the Development of Prediction Technology of Wind and Photovoltaic Power Generation," *Proc. ICSGCE*, vol. 12. Chengdu, China, pp. 601–608, 2011, doi: 10.1016/j.egypro.2011.10.081.
- [56] C. Wan, J. Zhao, Y. Song, Z. Xu, J. Lin, and Z. Hu, "Photovoltaic and Solar Power Forecasting for Smart Grid Energy Management," *CSEE J. Power Energy Syst.*, vol. 1, no. 4, pp. 38–46, 2015, [Online]. Available: http://ieeexplore.ieee.org/xpls/abs_all.jsp?arnumber=7377167.
- [57] J. Shi, W. J. Lee, Y. Q. Liu, Y. P. Yang, and P. Wang, "Forecasting Power Output of Photovoltaic Systems Based on Weather Classification and Support Vector Machines," *Ieee Trans. Ind. Appl.*, vol. 48, no. 3, pp. 1064–1069, 2012, doi: 10.1109/Tia.2012.2190816.
- [58] R. J. Bessa, A. Trindade, C. S. P. Silva, and V. Miranda, "Probabilistic Solar Power Forecasting in Smart Grids using Distributed Information," *Int. J. Electr. Power Energy Syst.*, vol. 72, no., pp. 16–23, 2015, doi: 10.1016/j.ijepes.2015.02.006.
- [59] A. Bracale, P. Caramia, G. Carpinelli, A. R. Di Fazio, and G. Ferruzzi, "A Bayesian Method for Short-Term Probabilistic Forecasting of Photovoltaic Generation in

- Smart Grid Operation and Control,” *Energies*, vol. 6, no. 2, pp. 733–747, 2013, doi: 10.3390/en6020733.
- [60] A. Arulampalam, M. Barnes, A. Engler, A. Goodwin, and N. Jenkins, “Control of Power Electronic Interfaces in Distributed Generation Microgrids,” *Int. J. Electron.*, vol. 91, no. 9, pp. 503–523, 2004, doi: 10.1080/00207210412331289023.
- [61] E. Unamuno and J. A. Barrena, “Hybrid ac/dc microgrids Part II: Review and classification of control strategies,” *Renew. Sustain. Energy Rev.*, vol. 52, no., pp. 1123–1134, 2015, doi: 10.1016/j.rser.2015.07.186.
- [62] J. Rocabert, A. Luna, F. Blaabjerg, and P. Rodriguez, “Control of Power Converters in AC Microgrids,” *Ieee Trans. Power Electron.*, vol. 27, no. 11, pp. 4734–4749, 2012, doi: 10.1109/Tpel.2012.2199334.
- [63] M. Mehraza, E. Pouresmaeil, H. Mehrjerdi, B. N. Jorgensen, and J. P. S. Catalao, “Control Technique for Enhancing the Stable Operation of Distributed Generation Units within a Microgrid,” *Energy Convers. Manag.*, vol. 97, no., pp. 362–373, 2015, doi: 10.1016/j.enconman.2015.03.078.
- [64] T. L. Vandoorn, J. Van de Vyver, B. Meersman, B. Zwaenepoel, and L. Vandeveldel, “Phase Unbalance Mitigation by Three-phase Damping Voltage-based Droop Controllers in Microgrids,” *Electr. Power Syst. Res.*, vol. 127, pp. 230–239, 2015, doi: 10.1016/j.epsr.2015.06.013.
- [65] T. L. Vandoorn, B. Renders, L. Degroote, B. Meersman, and L. Vandeveldel, “Active Load Control in Islanded Microgrids Based on the Grid Voltage,” *IEEE Trans. Smart Grid*, vol. 2, no. 1, pp. 139–151, 2011, doi: 10.1109/Tsg.2010.2090911.
- [66] H. Mahmood, D. Michaelson, and J. Jiang, “Reactive Power Sharing in Islanded Microgrids Using Adaptive Voltage Droop Control,” *IEEE Trans. Smart Grid*, vol. 6, no. 6, pp. 3052–3060, 2015, doi: 10.1109/Tsg.2015.2399232.
- [67] A. M. A Li-nu-er, Q. Chao, E. Y. B. Tu, and J. Luo, “Application of Fuzzy Control for the Energy Storage System in Improving Wind Power Prediction Accuracy,” *Am. J. Energy Res.*, vol. 1, no. 3, pp. 54–58, 2013, [Online]. Available: <http://pubs.sciepub.com/ajer/1/3/3/index.html>.
- [68] A. D. Zeng, Q. S. Xu, M. S. Ding, K. Yukita, and K. Ichiyanagi, “A Classification Control Strategy for Energy Storage System in Microgrid,” *IEEE Trans. Electr. Electron. Eng.*, vol. 10, no. 4, pp. 396–403, 2015, doi: 10.1002/tee.22099.
- [69] G. Capizzi, F. Bonanno, and G. M. Tina, “Recurrent Neural Network-Based Modeling and Simulation of Lead-Acid Batteries Charge-Discharge,” *Ieee Trans. Energy Convers.*, vol. 26, no. 2, pp. 435–443, 2011, doi: 10.1109/Tec.2010.2095015.
- [70] E. Ancillotti, R. Bruno, and M. Conti, “The Role of Communication Systems in Smart Grids: Architectures, Technical Solutions and Research Challenges,” *Comput. Commun.*, vol. 36, no. 17–18, pp. 1665–1697, 2013, doi: 10.1016/j.comcom.2013.09.004.
- [71] V. C. Gungor *et al.*, “Smart Grid Technologies: Communication Technologies and Standards,” *Ieee Trans. Ind. Informatics*, vol. 7, no. 4, pp. 529–539, 2011, doi: 10.1109/Tii.2011.2166794.
- [72] S. S. S. R. Depuru, L. F. Wang, and V. Devabhaktuni, “Smart Meters for Power Grid: Challenges, Issues, Advantages and Status,” *Renew. Sustain. Energy Rev.*, vol. 15, no. 6, pp. 2736–2742, 2011, doi: 10.1016/j.rser.2011.02.039.
- [73] P. Siano, “Demand Response and Smart Grids-A Survey,” *Renew. Sustain. Energy Rev.*, vol. 30, pp. 461–478, 2014, doi: 10.1016/j.rser.2013.10.022.

- [74] I. Opris and L. Caracasian, "The Relation between Smart Meters and Electricity Consumers," *EEEIC*. Wroclaw, pp. 325–329, 2013, [Online]. Available: http://ieeexplore.ieee.org/xpls/abs_all.jsp?arnumber=6549536.
- [75] Q. D. Ho, Y. Gao, G. Rajalingham, and T. Le-Ngoc, "Smart Grid Communications Network (SGCN)," in *Wireless Communications Networks for the Smart Grid*, 1st ed., Springer, 2014, pp. 15–30.
- [76] S. Elyengui, R. Bouhouchi, and T. Ezzedine, "The Enhancement of Communication Technologies and Networks for Smart Grid Applications," *Int. J. Emerg. Trends Tech. Comp. Sc.*, vol. 2, no. 6, pp. 107–115, 2013, [Online]. Available: <http://arxiv.org/ftp/arxiv/papers/1403/1403.0530.pdf>.
- [77] D. Chen, J. Brown, and J. Y. Khan, "6LoWPAN based Neighborhood Area Network for a Smart Grid Communication Infrastructure," *ICUFN*. Da Nang, pp. 576–581, 2013.
- [78] P. Dusa, C. Novac, E. Purice, O. Dodun, and L. Slatineanu, "Configuration a Meter Data Management System using Axiomatic Design," *ICAD*, vol. 34. Florence, Italy, pp. 174–179, 2015, doi: 10.1016/j.procir.2015.07.042.
- [79] S. Galli, A. Scaglione, and Z. F. Wang, "For the Grid and Through the Grid: The Role of Power Line Communications in the Smart Grid," *Proc. Ieee*, vol. 99, no. 6, pp. 998–1027, 2011, doi: 10.1109/Jproc.2011.2109670.
- [80] A. Mannan, D. K. Saxena, and M. Bandy, "A Study on Power Line Communication," *Int. J. Sci. Res. Pub.*, vol. 4, no. 7, pp. 1–4, 2014, [Online]. Available: <http://www.ijsrp.org/research-paper-0714/ijsrp-p3152.pdf>.
- [81] W. Y. Wang, Y. Xu, and M. Khanna, "A Survey on the Communication Architectures in Smart Grid," *Comput. Networks*, vol. 55, no. 15, pp. 3604–3629, 2011, doi: 10.1016/j.comnet.2011.07.010.
- [82] R. F. Ma, H. H. Chen, Y. R. Huang, and W. X. Meng, "Smart Grid Communication: Its Challenges and Opportunities," *IEEE Trans. Smart Grid*, vol. 4, no. 1, pp. 36–46, 2013, doi: 10.1109/Tsg.2012.2225851.
- [83] E. Fadel *et al.*, "A Survey on Wireless Sensor Networks for Smart Grid," *Comput. Commun.*, vol. 71, no., pp. 22–33, 2015, doi: 10.1016/j.comcom.2015.09.006.
- [84] B. Fateh, M. Govindarasu, and V. Ajarapu, "Wireless Network Design for Transmission Line Monitoring in Smart Grid," *IEEE Trans. Smart Grid*, vol. 4, no. 2, pp. 1076–1086, 2013, doi: 10.1109/Tsg.2013.2241796.
- [85] Wi-Fi Alliance, "Wi-Fi® for the Smart Grid Mature, Interoperable, Secure Technology for Advanced Smart Energy Management Communications," 2010.
- [86] J. F. Aguirre and F. Magnago, "Viability of WiMax for Smart Grid Distribution Network," *Eur. Int. J. Sci. Tech.*, vol. 2, no. 3, pp. 181–196, 2013, [Online]. Available: http://www.cekinform.org.uk/images/frontImages/gallery/Vol.2_No._3_April_2013/15.pdf.
- [87] V. Daravath and A. Daravath, "WIMAX (IEEE 802.16) broad band technology for smart grid applications," *ICCSP*. Melmaruvathur, pp. 1273–1275, 2015, [Online]. Available: http://ieeexplore.ieee.org/xpls/abs_all.jsp?arnumber=7322712&tag=1.
- [88] I. Silicon Laboratories, "ZigBee-based Home Area Networks Enable Smarter Energy Management." [Online]. Available: <https://www.silabs.com/Support Documents/TechnicalDocs/ZigBee-based-HANs-for-Energy-Management.pdf>.
- [89] Q. Zhang, Y. Sun, and Z. Cui, "Application and Analysis of ZigBee Technology for Smart Grid," *ICCIA*. Tianjin, pp. 171–174, 2010, [Online]. Available: http://ieeexplore.ieee.org/xpls/abs_all.jsp?arnumber=6141563.
- [90] F. Katiraei, R. Iravani, N. Hatziargyriou, and A. Dimeas, "Microgrids

- Management,” *Ieee Power Energy Mag.*, vol. 6, no. 3, pp. 54–65, 2008, doi: 10.1109/Mpe.2008.918702.
- [91] W. Su and J. Wang, “Energy Management Systems in Microgrid Operations,” *Electr. J.*, vol. 25, no. 8, pp. 45–60, 2012, [Online]. Available: <http://www.sciencedirect.com/science/article/pii/S104061901200214X>.
- [92] Y. W. Li and F. Nejabatkhah, “Overview of Control, Integration and Energy Management of Microgrids,” *J. Mod. Power Syst. Clean Energy*, vol. 2, no. 3, pp. 212–222, 2014, doi: 10.1007/s40565-014-0063-1.
- [93] D. E. Olivares, C. A. Canizares, and M. Kazerani, “A Centralized Energy Management System for Isolated Microgrids,” *IEEE Trans. Smart Grid*, vol. 5, no. 4, pp. 1864–1875, 2014, doi: 10.1109/Tsg.2013.2294187.
- [94] A. G. Tsikalakis and N. D. Hatziargyriou, “Centralized Control for Optimizing Microgrids Operation,” *Ieee Trans. Energy Convers.*, vol. 23, no. 1, pp. 241–248, 2008, doi: 10.1109/Tec.2007.914686.
- [95] P. Borazjani, N. I. A. Wahab, H. B. Hizam, and A. B. C. Soh, “A Review on Microgrid Control Techniques,” *ISGT*. Kuala Lumpur, pp. 749–753, 2014.
- [96] A. Kaur, J. Kaushal, and P. Basak, “A review on microgrid central controller,” *Renew. Sustain. Energy Rev.*, vol. 55, pp. 338–345, Mar. 2016, doi: 10.1016/j.rser.2015.10.141.
- [97] O. Palizban, K. Kauhaniemi, and J. M. Guerrero, “Microgrids in Active Network Management-Part I: Hierarchical Control, Energy Storage, Virtual Power Plants, and Market Participation,” *Renew. Sustain. Energy Rev.*, vol. 36, no., pp. 428–439, 2014, doi: 10.1016/j.rser.2014.01.016.
- [98] L. I. Minchala-Avila, L. E. Garza-Castanon, A. Vargas-Martinez, and Y. M. Zhang, “A Review of Optimal Control Techniques Applied to the Energy Management and Control of Microgrids,” *ANT-SEIT*, vol. 52. London, pp. 780–787, 2015, doi: 10.1016/j.procs.2015.05.133.
- [99] A. L. Dimeas and N. D. Hatziargyriou, “A MAS Architecture for Microgrids Control,” *Proc. ISAP*. Arlington, VA, pp. 402–406, 2005.
- [100] D. E. Olivares, C. A. Canizares, and M. Kazerani, “A Centralized Optimal Energy Management System for Microgrids,” *IEEE Power and Energy Society General Meeting*. San Diego, CA, pp. 1–6, 2011, doi: 10.1109/Pes.2011.6039527.
- [101] E. Planas, A. Gil-de-Muro, J. Andreu, I. Kortabarria, and I. M. de Alegria, “General Aspects, Hierarchical Controls and Droop Methods in Microgrids: A Review,” *Renew. Sustain. Energy Rev.*, vol. 17, no., pp. 147–159, 2013, doi: 10.1016/j.rser.2012.09.032.
- [102] J. Y. Yong, V. K. Ramachandaramurthy, K. M. Tan, and N. Mithulananthan, “A Review on the State-of-the-art Technologies of Electric Vehicle, Its Impacts and Prospects,” *Renew. Sustain. Energy Rev.*, vol. 49, no., pp. 365–385, 2015, doi: 10.1016/j.rser.2015.04.130.
- [103] F. Mwasilu, J. J. Justo, E. K. Kim, T. D. Do, and J. W. Jung, “Electric Vehicles and Smart Grid Interaction: A Review on Vehicle to Grid and Renewable Energy Sources Integration,” *Renew. Sustain. Energy Rev.*, vol. 34, no., pp. 501–516, 2014, doi: 10.1016/j.rser.2014.03.031.
- [104] T. G. S. Román, I. Momber, M. R. Abbad, and Á. S. Miralles, “Regulatory Framework and Business Models for Charging Plug-in Electric Vehicles: Infrastructure, Agents, and Commercial Relationships,” *Energy Policy*, vol. 39, no. 10, pp. 6360–6375, 2011, [Online]. Available: <http://www.sciencedirect.com/science/article/pii/S0301421511005696>.
- [105] E. Sortomme and M. A. El-Sharkawi, “Optimal Charging Strategies for

- Unidirectional Vehicle-to-Grid,” *IEEE Trans. Smart Grid*, vol. 2, no. 1, pp. 131–138, 2011, doi: 10.1109/Tsg.2010.2090910.
- [106] K. M. Tan, V. K. Ramachandaramurthy, and J. Y. Yong, “Integration of Electric Vehicles in Smart Grid: A Review on Vehicle to Grid Technologies and Optimization Techniques,” *Renew. Sustain. Energy Rev.*, vol. 53, no., pp. 720–732, 2016, doi: 10.1016/j.rser.2015.09.012.
- [107] M. Soshinskaya, W. H. J. Crijns-Graus, J. M. Guerrero, and J. C. Vasquez, “Microgrids: Experiences, Barriers and Success Factors,” *Renew. Sustain. Energy Rev.*, vol. 40, no., pp. 659–672, 2014, doi: 10.1016/j.rser.2014.07.198.
- [108] A. A. Salam, A. Mohamed, and M. A. Hannan, “Technical Challenges on Microgrids,” *ARNP J. Eng. Appl. Sc.*, vol. 3, no. 6, pp. 64–69, 2008, [Online]. Available: http://www.arnpjournals.com/jeas/research_papers/rp_2008/jeas_1208_146.pdf.
- [109] R. Zamora and A. K. Srivastava, “Controls for Microgrids with Storage: Review, Challenges, and Research Needs,” *Renew. Sustain. Energy Rev.*, vol. 14, no. 7, pp. 2009–2018, 2010, doi: 10.1016/j.rser.2010.03.019.
- [110] W. Bower *et al.*, “The Advanced Microgrid Integration and Interoperability,” New Mexico - California, 2014.
- [111] NIST_RSEI, “Workshop on Technology, Measurement, and Standards Challenges for the Smart Grid,” 2013.
- [112] C. P. Vineetha and C. A. Babu, “Smart Grid Challenges, Issues and Solutions,” *IGBSG*. Taipei, pp. 1–4, 2014.
- [113] A. Gaviano, K. Weber, and C. Dirmeier, “Challenges and Integration of PV and Wind Energy Facilities from a Smart Grid Point of View,” *APVIA*, vol. 25. Singapore, pp. 118–125, 2012, doi: 10.1016/j.egypro.2012.07.016.
- [114] M. Stadler *et al.*, “Value Streams in Microgrids: A Literature Review,” *Appl. Energy*, vol. 162, pp. 980–989, 2016, doi: 10.1016/j.apenergy.2015.10.081.
- [115] L. Che, M. E. Khodayar, and M. Shahidehpour, “Adaptive Protection System for Microgrids: Protection Practices of a Functional Microgrid System,” *IEEE Electr. Mag.*, vol. 2, no. 1, pp. 66–80, 2014, [Online]. Available: <http://ieeexplore.ieee.org/stamp/stamp.jsp?tp=&arnumber=6774516>.
- [116] S. Mirsaedi, D. M. Said, M. W. Mustafa, M. H. Habibuddin, and K. Ghaffari, “Progress and Problems in Microgrid Protection Schemes,” *Renew. Sustain. Energy Rev.*, vol. 37, no., pp. 834–839, 2014, doi: 10.1016/j.rser.2014.05.044.
- [117] P. Basak, S. Chowdhury, S. H. N. Dey, and S. P. Chowdhury, “A Literature Review on Integration of Distributed Energy Resources in the Perspective of Control, Protection and Stability of Microgrid,” *Renew. Sustain. Energy Rev.*, vol. 16, no. 8, pp. 5545–5556, 2012, doi: 10.1016/j.rser.2012.05.043.
- [118] A. Kumar and M. L. Azad, “Challenges in Recent Microgrid Systems: A Review,” *Int. J. Adv. Eng. Tech.*, vol. 8, no. 2, pp. 203–210, 2015, [Online]. Available: <http://www.e-ijaet.org/media/22I26-IJAET0826401-v8-iss2-pp203-210.pdf>.
- [119] A. Schulke, J. Bauknecht, and J. Haussler, “Power Demand Shifting with Smart Consumers A Platform for Power Grid friendly Consumption Control Strategies,” *Smartgridcomm*. Gaithersburg, MD, pp. 437–442, 2010.
- [120] A. Molderink, V. Bakker, M. G. C. Bosman, J. L. Hurink, and G. J. M. Smit, “Management and Control of Domestic Smart Grid Technology,” *IEEE Trans. Smart Grid*, vol. 1, no. 2, pp. 109–119, 2010, doi: 10.1109/Tsg.2010.2055904.
- [121] M. Vasirani and S. Ossowski, “Smart Consumer Load Balancing: State of the Art and an Empirical Evaluation in the Spanish Electricity Market,” *Artif. Intell. Rev.*, vol. 39, no. 1, pp. 81–95, 2013, doi: 10.1007/s10462-012-9391-6.

- [122] Z. Shuai *et al.*, “Microgrid stability: Classification and a review,” *Renewable and Sustainable Energy Reviews*, vol. 58. Elsevier Ltd, pp. 167–179, May 01, 2016, doi: 10.1016/j.rser.2015.12.201.
- [123] M. A. Zamani, T. S. Sidhu, and A. Yazdani, “A Protection Strategy and Microprocessor-Based Relay for Low-Voltage Microgrids,” *IEEE Trans. Power Deliv.*, vol. 26, no. 3, pp. 1873–1883, 2011, [Online]. Available: http://ieeexplore.ieee.org/xpls/abs_all.jsp?arnumber=5746636.
- [124] N. Schaefer, T. Degner, A. Shustov, KeilT., and JaegerJ., “Adaptive protection system for distribution networks with distributed energy resources,” *DPSP*. Manchester, pp. 1–5, 2010.
- [125] H. Nikkhajoei, R. H. Lasseter, and P. I. E. R. E. Commission, “Microgrid Fault Protection Based on Symmetrical and Differential Current Components,” University of Wisconsin-Madison, 2006.
- [126] S. R. Samantaray, G. Joos, and I. Kamwa, “Differential energy based microgrid protection against fault conditions,” *ISGT*. Washington, DC, pp. 1–7, 2012.
- [127] N. Jayawarna and M. Barnes, “Central Storage Unit Response Requirement in ‘Good Citizen’ Microgrid,” *EPE*, vol. 1–9. Barcelona, pp. 1–10, 2009.
- [128] M. E. Khodayar, M. Barati, and M. Shahidehpour, “Integration of High Reliability Distribution System in Microgrid Operation,” *IEEE Trans. Smart Grid*, vol. 3, no. 4, pp. 1997–2006, 2012, doi: 10.1109/Tsg.2012.2213348.
- [129] Z. Y. Wang and J. H. Wang, “Self-Healing Resilient Distribution Systems Based on Sectionalization Into Microgrids,” *Ieee Trans. Power Syst.*, vol. 30, no. 6, pp. 3139–3149, 2015, doi: 10.1109/Tpwr.2015.2389753.
- [130] M. Mahmoodi, P. Shamsi, and B. Fahimi, “Economic Dispatch of a Hybrid Microgrid With Distributed Energy Storage,” *IEEE Trans. Smart Grid*, vol. 6, no. 6, pp. 2607–2614, 2015, doi: 10.1109/Tsg.2014.2384031.
- [131] A. Khodaei and M. Shahidehpour, “Microgrid-Based Co-Optimization of Generation and Transmission Planning in Power Systems,” *Ieee Trans. Power Syst.*, vol. 28, no. 2, pp. 1582–1590, 2013, doi: 10.1109/Tpwr.2012.2224676.
- [132] C. Ahn and H. Peng, “Decentralized Voltage Control to Minimize Distribution Power Loss of Microgrids,” *IEEE Trans. Smart Grid*, vol. 4, no. 3, pp. 1297–1304, 2013, doi: 10.1109/Tsg.2013.2248174.
- [133] C. N. Papadimitriou, V. A. Kleftakis, and N. D. Hatziargyriou, “A novel islanding detection method for microgrids based on variable impedance insertion,” *Electr. Power Syst. Res.*, vol. 121, pp. 58–66, 2015, doi: 10.1016/j.epsr.2014.12.004.
- [134] A. Dolara, F. Grimaccia, G. Magistrati, and G. Marchegiani, “Optimization Models for Islanded Micro-Grids: A Comparative Analysis between Linear Programming and Mixed Integer Programming,” *Energies*, vol. 10, no. 2, 2017, doi: Unsp 24110.3390/En10020241.
- [135] A. C. Luna, N. L. Diaz, M. Graells, J. C. Vasquez, and J. M. Guerrero, “Mixed-Integer-Linear- Programming-Based Energy Management System for Hybrid PV-Wind-Battery Microgrids: Modeling, Design, and Experimental Verification,” *Ieee Trans. Power Electron.*, vol. 32, no. 4, pp. 2769–2783, 2017, doi: 10.1109/Tpel.2016.2581021.
- [136] L. N. An and T. Q. Tuan, “Dynamic programming for optimal energy management of hybrid wind-pv-diesel-battery,” *Energies*, vol. 11, no. 11, pp. 1–16, 2018, doi: Artn 303910.3390/En11113039.
- [137] B. Khan and P. Singh, “Selecting a meta-heuristic technique for smart micro-grid optimization problem: a comprehensive analysis,” *IEEE Access*, vol. 5, pp. 13951–13977, 2017, doi: 10.1109/Access.2017.2728683.

- [138] M. F. Zia, E. Elbouchikhi, and M. Benbouzid, "Microgrids energy management systems: a critical review on methods, solutions, and prospects," *Appl. Energy*, vol. 222, pp. 1033–1055, 2018, doi: 10.1016/j.apenergy.2018.04.103.
- [139] L. X. Meng, E. R. Sanseverino, A. Luna, T. Dragicevic, J. C. Vasquez, and J. M. Guerrero, "Microgrid supervisory controllers and energy management systems: a literature review," *Renew. Sustain. Energy Rev.*, vol. 60, pp. 1263–1273, 2016, doi: 10.1016/j.sser.2016.03.003.
- [140] H. Farzin, M. Fotuhi-Firuzabad, and M. Moeini-Aghtaie, "Enhancing power system resilience through hierarchical outage management in multi-microgrids," *IEEE Trans. Smart Grid*, vol. 7, no. 6, pp. 2869–2879, 2016, doi: 10.1109/Tsg.2016.2558628.
- [141] X. D. Yang, Y. B. Zhang, H. B. He, S. J. Ren, and G. Q. Weng, "Real-time demand side management for a microgrid considering uncertainties," *IEEE Trans. Smart Grid*, vol. 10, no. 3, pp. 3401–3414, 2019, doi: 10.1109/Tsg.2018.2825388.
- [142] F. Valencia, J. Collado, D. Saez, and L. G. Marin, "Robust Energy Management System for a Microgrid Based on a Fuzzy Prediction Interval Model," *IEEE Trans. Smart Grid*, vol. 7, no. 3, pp. 1486–1494, 2016, doi: 10.1109/Tsg.2015.2463079.
- [143] F. Valencia, D. Saez, J. Collado, F. Avila, A. Marquez, and J. J. Espinosa, "Robust Energy Management System Based on Interval Fuzzy Models," *Ieee Trans. Control Syst. Technol.*, vol. 24, no. 1, pp. 140–157, 2016, doi: 10.1109/Tcst.2015.2421334.
- [144] P. Malysz, S. Sirouspour, and A. Emadi, "An Optimal Energy Storage Control Strategy for Grid-connected Microgrids," *IEEE Trans. Smart Grid*, vol. 5, no. 4, pp. 1785–1796, 2014, doi: 10.1109/Tsg.2014.2302396.
- [145] T. Schittekatte, M. Stadler, G. Cardoso, S. Mashayekh, and N. Sankar, "The Impact of Short-Term Stochastic Variability in Solar Irradiance on Optimal Microgrid Design," *IEEE Trans. Smart Grid*, vol. 9, no. 3, pp. 1647–1656, 2018, doi: 10.1109/Tsg.2016.2596709.
- [146] A. Parisio, E. Rikos, and L. Glielmo, "A Model Predictive Control Approach to Microgrid Operation Optimization," *Ieee Trans. Control Syst. Technol.*, vol. 22, no. 5, pp. 1813–1827, 2014, doi: 10.1109/Tcst.2013.2295737.
- [147] R. Rigo-Mariani, B. Sareni, and X. Roboam, "Integrated Optimal Design of a Smart Microgrid With Storage," *IEEE Trans. Smart Grid*, vol. 8, no. 4, pp. 1762–1770, 2017, doi: 10.1109/Tsg.2015.2507131.
- [148] R. Palma-Behnke *et al.*, "A Microgrid Energy Management System Based on the Rolling Horizon Strategy," *IEEE Trans. Smart Grid*, vol. 4, no. 2, pp. 996–1006, 2013, doi: 10.1109/Tsg.2012.2231440.
- [149] M. R. Sandgani and S. Sirouspour, "Coordinated Optimal Dispatch of Energy Storage in a Network of Grid-Connected Microgrids," *Ieee Trans. Sustain. Energy*, vol. 8, no. 3, pp. 1166–1176, 2017, doi: 10.1109/Tste.2017.2664666.
- [150] Q. L. Wei, D. R. Liu, Y. Liu, and R. Z. Song, "Optimal Constrained Self-learning Battery Sequential Management in Microgrid Via Adaptive Dynamic Programming," *Ieee-Caa J. Autom. Sin.*, vol. 4, no. 2, pp. 168–176, 2017, doi: 10.1109/Jas.2016.7510262.
- [151] Q. L. Wei, D. R. Liu, F. L. Lewis, Y. Liu, and J. Zhang, "Mixed Iterative Adaptive Dynamic Programming for Optimal Battery Energy Control in Smart Residential Microgrids," *Ieee Trans. Ind. Electron.*, vol. 64, no. 5, pp. 4110–4120, 2017, doi: 10.1109/Tie.2017.2650872.
- [152] H. Farzin, M. Fotuhi-Firuzabad, and M. Moeini-Aghtaie, "Stochastic Energy Management of Microgrids During Unscheduled Islanding Period," *Ieee Trans.*

- Ind. Informatics*, vol. 13, no. 3, pp. 1079–1087, 2017, doi: 10.1109/Tii.2016.2646721.
- [153] H. Alharbi and K. Bhattacharya, “Stochastic Optimal Planning of Battery Energy Storage Systems for Isolated Microgrids,” *IEEE Trans. Sustain. Energy*, vol. 9, no. 1, pp. 211–227, 2018, doi: 10.1109/Tste.2017.2724514.
- [154] Y. Qin, H. Hua, and J. Cao, “Stochastic Optimal Control Scheme for Battery Lifetime Extension in Islanded Microgrid via A Novel Modeling Approach,” *IEEE Transactions Smart Grid*.
- [155] L. M. Costa and G. Kariniotakis, “A stochastic dynamic programming model for optimal use of local energy resources in a market environment,” *2007 Ieee Lausanne Powertech, Vols 1-5*, pp. 449–454, 2007, doi: Doi 10.1109/Pct.2007.4538359.
- [156] B. Heymann, J. F. Bonnans, P. Martinon, F. J. Silva, F. Lanas, and G. Jimenez-Estevez, “Continuous optimal control approaches to microgrid energy management,” *Energy Syst. Model. Simul. Econ. Asp.*, vol. 9, no. 1, pp. 59–77, 2018, doi: 10.1007/s12667-016-0228-2.
- [157] N. A. Luu and Q. T. Tran, “Optimal energy management for grid connected microgrid by using Dynamic programming method,” *2015 Ieee Power Energy Soc. Gen. Meet.*, 2015.
- [158] M. Strelec and J. Berka, “Microgrid Energy Management based on Approximate Dynamic Programming,” *2013 4th Ieee/Pes Innov. Smart Grid Technol. Eur. (Isgt Eur.)*, 2013, doi: 10.1109/ISGTEurope.2013.6695439.
- [159] Y. Liu, C. Yuen, N. Ul Hassan, S. S. Huang, R. Yu, and S. L. Xie, “Electricity cost minimization for a microgrid with distributed energy resource under different information savailability,” *IEEE Trans. Ind. Electron.*, vol. 62, no. 4, pp. 2571–2583, 2015, doi: 10.1109/Tie.2014.2371780.
- [160] M. Marzband, H. Alavi, S. S. Ghazimirsaeid, H. Uppal, and T. Fernando, “Optimal energy management system based on stochastic approach fora home Microgrid with integrated responsive load demand and energy storage,” *Sustain. Cities Soc.*, vol. 28, pp. 256–264, 2017, doi: 10.1016/j.scs.2016.09.017.
- [161] V. S. Tabar, M. A. Jirdehi, and R. Hemmati, “Energy management in microgrid based on the multi objective stochastic programming incorporating portable renewable energy resource as demand response option,” *Energy*, vol. 118, pp. 827–839, 2017, doi: 10.1016/j.energy.2016.10.113.
- [162] A. Nadimi and F. Adabi, “Optimized Planning for Hybrid Microgrid in Grid-Connected Mode,” *Int. J. Renew. Energy Res.*, vol. 6, no. 2, pp. 494–503, 2016.
- [163] P. Stluka, D. Godbole, and T. Samad, “Energy Management for Buildings and Microgrids,” *2011 50th Ieee Conf. Decis. Control Eur. Control Conf.*, pp. 5150–5157, 2011.
- [164] Z. C. Shi, H. Liang, S. J. Huang, and V. Dinavahi, “Distributionally Robust Chance-Constrained Energy Management for Islanded Microgrids,” *IEEE Trans. Smart Grid*, vol. 10, no. 2, pp. 2234–2244, 2019, doi: 10.1109/Tsg.2018.2792322.
- [165] L. Guo, W. J. Liu, B. Q. Jiao, B. W. Hong, and C. S. Wang, “Multi-objective stochastic optimal planning method for stand-alone microgrid system,” *Iet Gener. Transm. Distrib.*, vol. 8, no. 7, pp. 1263–1273, 2014, doi: 10.1049/iet-gtd.2013.0541.
- [166] V. Mohan, R. Suresh, J. G. Singh, W. Ongsakul, and N. Madhu, “Microgrid Energy Management Combining Sensitivities, Interval and Probabilistic Uncertainties of Renewable Generation and Loads,” *Ieee J. Emerg. Sel. Top. Circuits Syst.*, vol. 7, no. 2, pp. 262–270, 2017, doi: 10.1109/Jetcas.2017.2679030.

- [167] V. Mohan, J. G. Singh, and W. Ongsakul, "Sortino Ratio Based Portfolio Optimization Considering EVs and Renewable Energy in Microgrid Power Market," *Ieee Trans. Sustain. Energy*, vol. 8, no. 1, pp. 219–229, 2017, doi: 10.1109/Tste.2016.2593713.
- [168] M. Manbachi and M. Ordóñez, "AMI-Based Energy Management for Islanded AC/DC Microgrids Utilizing Energy Conservation and Optimization," *IEEE Trans. Smart Grid*, vol. 10, no. 1, pp. 293–304, 2019, doi: 10.1109/Tsg.2017.2737946.
- [169] M. Marzband, F. Azarinejadian, M. Savaghebi, and J. M. Guerrero, "An Optimal Energy Management System for Islanded Microgrids Based on Multiperiod Artificial Bee Colony Combined With Markov Chain," *Ieee Syst. J.*, vol. 11, no. 3, pp. 1712–1722, 2017, doi: 10.1109/Jsys.2015.2422253.
- [170] H. Shuai, J. K. Fang, X. M. Ai, Y. F. Tang, J. Y. Wen, and H. B. He, "Stochastic optimization of economic dispatch for microgrid based on approximate dynamic programming," *IEEE Trans. Smart Grid*, vol. 10, no. 3, pp. 2440–2452, 2019, doi: 10.1109/Tsg.2018.2798039.
- [171] W. B. Shi, N. Li, C. C. Chu, and R. Gadh, "Real-Time Energy Management in Microgrids," *IEEE Trans. Smart Grid*, vol. 8, no. 1, pp. 228–238, 2017, doi: 10.1109/Tsg.2015.2462294.
- [172] J. S. Shen, C. W. Jiang, Y. Y. Liu, and X. Wang, "A Microgrid Energy Management System and Risk Management Under an Electricity Market Environment," *Ieee Access*, vol. 4, 2016, doi: 10.1109/Access.2016.2555926.
- [173] S. R. Cominesi, M. Farina, L. Giulioni, B. Picasso, and R. Scattolini, "A Two-Layer Stochastic Model Predictive Control Scheme for Microgrids," *IEEE Trans. Control Syst. Technol.*, vol. 26, no. 1, pp. 1–13, 2018, doi: 10.1109/Tcst.2017.2657606.
- [174] T. Wang, D. O'Neill, and H. Kamath, "Dynamic Control and Optimization of Distributed Energy Resources in a Microgrid," *IEEE Trans. Smart Grid*, vol. 6, no. 6, pp. 2884–2894, 2015, doi: 10.1109/Tsg.2015.2430286.
- [175] P. Kou, D. L. Liang, and L. Gao, "Stochastic energy scheduling in microgrids considering the uncertainties in both supply and demand," *IEEE Syst. J.*, vol. 12, no. 3, pp. 2589–2600, 2018, doi: 10.1109/Jsys.2016.2614723.
- [176] W. H. Hu, P. Wang, and H. B. Gooi, "Toward Optimal Energy Management of Microgrids via Robust Two-Stage Optimization," *IEEE Trans. Smart Grid*, vol. 9, no. 2, pp. 1161–1174, 2018, doi: 10.1109/Tsg.2016.2580575.
- [177] K. Rahbar, J. Xu, and R. Zhang, "Real-Time Energy Storage Management for Renewable Integration in Microgrid: An Off-Line Optimization Approach," *IEEE Trans. Smart Grid*, vol. 6, no. 1, pp. 124–134, 2015, doi: 10.1109/Tsg.2014.2359004.
- [178] W. C. Su, J. H. Wang, and J. Roh, "Stochastic Energy Scheduling in Microgrids With Intermittent Renewable Energy Resources," *IEEE Trans. Smart Grid*, vol. 5, no. 4, pp. 1876–1883, 2014, doi: 10.1109/Tsg.2013.2280645.
- [179] H. Kanchev, F. Colas, V. Lazarov, and B. Francois, "Emission reduction and economical optimization of an urban microgrid operation including dispatched PV-based active generators," *IEEE Trans. Sustain. Energy*, vol. 5, no. 4, pp. 1397–1405, 2014, doi: 10.1109/Tste.2014.2331712.
- [180] J. B. Han, S. Khushalani-Solanki, J. Solanki, and J. Q. Liang, "Adaptive critic design-based dynamic stochastic optimal control design for a microgrid with Multiple renewable resources," *IEEE Trans. Smart Grid*, vol. 6, no. 6, pp. 2694–2703, 2015, doi: 10.1109/Tsg.2015.2428435.

- [181] G. K. Venayagamoorthy, R. K. Sharma, P. K. Gautam, and A. Ahmadi, "Dynamic energy management system for a smart microgrid," *IEEE Trans. Neural Networks Learn. Syst.*, vol. 27, no. 8, pp. 1643–1656, 2016, doi: 10.1109/Tnnls.2016.2514358.
- [182] D. R. Liu, Y. C. Xu, Q. L. Wei, and X. L. Liu, "Residential Energy Scheduling for Variable Weather Solar Energy Based on Adaptive Dynamic Programming," *Ieee-Caa J. Autom. Sin.*, vol. 5, no. 1, pp. 36–46, 2018, doi: 10.1109/Jas.2017.7510739.
- [183] A. Das and Z. Ni, "A computationally efficient optimization approach for battery systems in islanded microgrid," *IEEE Trans. Smart Grid*, vol. 9, no. 6, pp. 6489–6499, 2018, doi: 10.1109/Tsg.2017.2713947.
- [184] H. Shuai, J. K. Fang, X. M. Ai, J. Y. Wen, and H. B. He, "Optimal real-time operation strategy for microgrid: an ADP-based stochastic nonlinear optimization approach," *IEEE Trans. Sustain. Energy*, vol. 10, no. 2, pp. 931–942, 2019, doi: 10.1109/Tste.2018.2855039.
- [185] P. Zeng, H. Li, H. He, and S. Li, "Dynamic Energy Management of a Microgrid Using Approximate Dynamic Programming and Deep Recurrent Neural Network Learning," *IEEE Trans. Smart Grid*, vol. 10, no. 4, pp. 4435–4445, 2019, doi: 10.1109/TSG.2018.2859821.
- [186] C. Bordons and F. Garcia-Torres, *Model Predictive Control of Microgrids*. Springer, 2020.
- [187] G. M. Kopanos and E. N. Pistikopoulos, "Reactive scheduling by a multiparametric programming rolling horizon framework: A case of a network of combined heat and power units," *Ind. Eng. Chem. Res.*, vol. 53, no. 11, pp. 4366–4386, 2014, doi: 10.1021/ie402393s.
- [188] R. S. Sutton and A. G. Barto, *Reinforcement Learning: An Introduction, 2nd Edition*. Cambridge, MA, USA: MIT Press, 2018.
- [189] H. Liang and W. Zhuang, "Stochastic modeling and optimization in a microgrid: A survey," *Energies*, vol. 7, no. 4, pp. 2027–2050, 2014, doi: 10.3390/en7042027.
- [190] S. Parhizi, H. Lotfi, A. Khodaei, and S. Bahramirad, "State of the Art in Research on Microgrids: A Review," *Ieee Access*, vol. 3, pp. 890–925, 2015, doi: 10.1109/Access.2015.2443119.
- [191] G. Wang and H. Hijazi, "Mathematical programming methods for microgrid design and operations: a survey on deterministic and stochastic approaches," *Comput. Optim. Appl.*, vol. 71, no. 2, pp. 553–608, 2018, doi: 10.1007/s10589-018-0015-1.
- [192] T. Niknam, R. Azizipanah-Abarghooee, and M. R. Narimani, "An efficient scenario-based stochastic programming framework for multi-objective optimal micro-grid operation," *Appl. Energy*, vol. 99, pp. 455–470, 2012, doi: 10.1016/j.apenergy.2012.04.017.
- [193] S. Mohammadi, S. Soleymani, and B. Mozafari, "Scenario-based stochastic operation management of MicroGrid including Wind, Photovoltaic, Micro-Turbine, Fuel Cell and Energy Storage Devices," *Int. J. Electr. Power Energy Syst.*, vol. 54, pp. 525–535, 2014, doi: 10.1016/j.ijepes.2013.08.004.
- [194] C. A. Hans, P. Sopasakis, J. Raisch, C. Reincke-Collon, and P. Patrinos, "Scenario-Based Model Predictive Operation Control of Islanded Microgrids," in *IEEE Conference on Decision and Control*, 2015, pp. 3272–3277, doi: 10.1109/TCST.2019.2929492.
- [195] J. Dupacova, N. Growe-Kuska, and W. Romisch, "Scenario reduction in stochastic programming- An approach using probability metrics Received:," *Math. Program.*, vol. 95, no. 3, pp. 493–511, 2003.

- [196] W. Römisch, “Scenario reduction techniques in stochastic programming,” in *Stochastic Algorithms: Foundations and Applications, 5th International Symposium, SAGA*, 2009, pp. 1–14, doi: 10.1007/978-3-642-04944-6_1.
- [197] J. Silvente, G. M. Kopanos, V. Dua, and L. G. Papageorgiou, “A rolling horizon approach for optimal management of microgrids under stochastic uncertainty,” *Chem. Eng. Res. Des.*, vol. 131, pp. 293–317, 2018, doi: 10.1016/j.cherd.2017.09.013.
- [198] A. Parisio, E. Rikos, and L. Glielmo, “Stochastic model predictive control for economic/environmental operation management of microgrids: An experimental case study,” *J. Process Control*, vol. 43, pp. 24–37, 2016, doi: 10.1016/j.jprocont.2016.04.008.
- [199] F. Garcia-Torres and C. Bordons, “Optimal Economical Schedule of Hydrogen-Based Microgrids With Hybrid Storage Using Model Predictive Control,” *IEEE Trans. Ind. Electron.*, vol. 62, no. 8, pp. 5195–5207, 2015, doi: 10.1109/TIE.2015.2412524.
- [200] A. Das and Z. Ni, “A Novel Fitted Rolling Horizon Control Approach for Real-Time Policy Making in Microgrid,” *IEEE Trans. Smart Grid*, vol. 11, no. 4, pp. 3535–3544, 2020.
- [201] D. F. Salas and W. B. Powell, “Benchmarking a scalable approximate dynamic programming algorithm for stochastic control of grid-level energy storage,” *Dept. Oper. Res. Financ. Eng., Princet. Univ., Princeton, NJ, USA*, 2013, doi: 10.1287/ijoc.2017.0768.
- [202] M. Sedighzadeh, M. Esmaili, A. Jamshidi, and M. H. Ghaderi, “Stochastic multi-objective economic-environmental energy and reserve scheduling of microgrids considering battery energy storage system,” *Int. J. Electr. Power Energy Syst.*, vol. 106, pp. 1–16, 2019, doi: 10.1016/j.ijepes.2018.09.037.
- [203] S. F. Contreras, C. A. Cortes, and J. M. A. Myrzik, “Optimal microgrid planning for enhancing ancillary service provision,” *J. Mod. Power Syst. Clean Energy*, vol. 7, no. 4, pp. 862–875, 2019, doi: 10.1007/s40565-019-0528-3.
- [204] J. Duan, Z. Yi, D. Shi, C. Lin, X. Lu, and Z. Wang, “Reinforcement-Learning-Based Optimal Control of Hybrid Energy Storage Systems in Hybrid AC–DC Microgrids,” *IEEE Trans. Ind. Informatics*, vol. 15, no. 9, pp. 5355–5364, 2019, doi: 10.1109/tii.2019.2896618.
- [205] F. Ruelens, B. J. Claessens, S. Vandael, B. De Schutter, R. Babuska, and R. Belmans, “Residential demand response of thermostatically controlled loads using batch reinforcement learning,” *IEEE Trans. Smart Grid*, vol. 8, no. 5, pp. 2149–2159, 2017, doi: 10.1109/Tsg.2016.2517211.
- [206] B. V Mbuwir, F. Ruelens, F. Spiessens, and G. Deconinck, “Battery energy management in a microgrid using batch reinforcement learning,” *Energies*, vol. 10, no. 11, 2017, doi: ARTN 184610.3390/en10111846.
- [207] Z. H. Ding, L. Y. Xie, Y. Lu, P. Wang, and S. W. Xia, “Emission-aware stochastic resource planning scheme for data center microgrid considering batch workload scheduling and risk management,” *IEEE Trans. Ind. Appl.*, vol. 54, no. 6, pp. 5599–5608, 2018, doi: 10.1109/Tia.2018.2851516.
- [208] Y. Lim and H. M. Kim, “Strategic bidding using reinforcement learning for load shedding in microgrids,” *Comput. Electr. Eng.*, vol. 40, no. 5, pp. 1439–1446, 2014, doi: 10.1016/j.compeleceng.2013.12.013.
- [209] E. Kuznetsova, Y. F. Li, C. Ruiz, E. Zio, G. Ault, and K. Bell, “Reinforcement learning for microgrid energy management,” *Energy*, vol. 59, pp. 133–146, 2013, doi: 10.1016/j.energy.2013.05.060.

- [210] E. Foruzan, L. K. Soh, and S. Asgarpoor, "Reinforcement learning approach for optimal distributed energy management in a microgrid," *IEEE Trans. Power Syst.*, vol. 33, no. 5, pp. 5749–5758, 2018, doi: 10.1109/Tpwr.2018.2823641.
- [211] P. Kofinas, A. I. Dounis, and G. A. Vouros, "Fuzzy Q-learning for multi-agent decentralized energy management in microgrids," *Appl. Energy*, vol. 219, pp. 53–67, 2018, doi: 10.1016/j.apenergy.2018.03.017.
- [212] X. Xu, Y. Jia, Y. Xu, Z. Xu, and C. S. Lai, "A multi-agent reinforcement learning-based data-driven method for home energy management," *IEEE Trans. Smart Grid*, vol. 11, no. 4, pp. 3201–3211, 2020, doi: 10.1109/TSG.2020.2971427.
- [213] S. Kim and H. Lim, "Reinforcement learning based energy management algorithm for smart energy buildings," *Energies*, vol. 11, no. 8, 2018, doi: Artn 201010.3390/En11082010.

CURRICULUM VITAE

2007 – 2011	B.Sc., Electrical - Electronics Engineering, Cumhuriyet University, Sivas, TURKEY
2011 – 2015	M.Sc., Electrical - Electronics Engineering, Çukurova University, Adana, TURKEY
2015 – 2021	Ph.D., Electrical and Computer Engineering, Abdullah Gül University, Kayseri, TURKEY
2015 – Present	Research Assistant, Electrical - Electronics Engineering, Abdullah Gül University, Kayseri, TURKEY

SELECTED PUBLICATIONS AND PRESENTATIONS

J1) Y. Yoldas, S. Goren, A. Onen and T. S. Ustun, Dynamic Rolling Horizon Approach for a University Campus, under review in Energy Reports.

J2) Y. Yoldas, S. Goren and A. Onen, Optimal Control of Microgrids with Multi-stage Mixed-integer Nonlinear Programming Guided Q-learning Algorithm, published in Journal of Modern Power Systems and Clean Energy (Nov. 2020).

J3) R. Koubaa, Y. Yoldas, S. Goren, L. Krichen, A. Onen, Implementation of cost benefit analysis of vehicle to grid coupled real Micro-Grid by considering battery energy wear: Practical study case, published in Energy & Environment (Oct. 2020).

J4) Y. Yoldas, A. Onen, R. Broadwater, I. Alan, Implementation of capital deferral algorithm in real distribution systems considering reliability by managing major faults”, published in Electrical Engineering (Oct. 2019)

J5) Y. Yoldas, A. Önen, S. M. Mueen, A. V. Vasilakos, I. Alan, Enhancing smart grid with microgrids: Challenges and opportunities, published in Renewable and Sustainable Energy Reviews (May 2017)

C1) Y. Yoldas, S. Goren, A. Onen and T. S. Ustun, Dynamic Rolling Horizon Approach for a University Campus in International Conference on Power and Energy Systems Engineering (Sep. 2021)

- C2)** Y.Yoldas, A. Önen, S. Goren, Optimal Energy Management for Microgrid of a University Campus in International Conference On Economics Energy And Environment (June 2020).
- C3)** R. Koubaa, Y.Yoldaş, A. Önen, S. Goren, Design of a V2G Charging Station Coupled with the Malta College of Arts Science and Technology Micro-Grid in International Conference On Economics Energy And Environment (June 2020).
- C4)** M. C. Kocer, Y. Yoldas, S.Goren, A. Onen, I. Alan, S.Al-Agtash, J. L. Martinez-Ramos, D. Tzovaras, L. Hadjidemetriou, Cloud Induced PV Impact on Voltage Profiles for Real Microgrids, International Symposium on Environment Friendly Energies and Applications (Sep. 2018).
- C5)** J. L. Martinez-Ramos, A. Marano-Marcolini, F. P. Garcia-Lopez, F. Almagro-Yravedra, A. Onen, Y. Yoldas, M. Khiat, L. Ghomriz, N. Fragalex, Provision of Ancillary Services by a Smart Microgrid: An OPF Approach in International Conference on Smart Energy Systems and Technologies (Sep. 2018).
- C6)** Y.Yoldas, A. Önen, R. P. Broadwater, I. Alan, Distribution Automation Effect on Reliability during Major Contingencies in IEEE PES International Conference on Harmonics & Quality of Power (May 2018).